



**Dünya Çocuk
Akademisi**

Ağaoğlu Maslak 1453

**3//ENJOY IT
TOGETHER**



APRIL 23

**HAPPY NATIONAL
SOVEREIGNTY AND
CHILDREN'S DAY**



BİZ KOÇAMAN BİR AİLEYİZ...



#zorluklarberaberasilir
#oncemoral
#guzelruhhali
#onceinsan
#COCUGUNGUCU
#OGRENMENIN GUCU
#OGRETMENINVARLIGI
#EGITIMOLMADANASLA

Dear Parents,

We trust that you are safe and healthy at home. We are excited to share with you a newly planned activities for our little students.

As you may know, April 23rd marks the holiday of national sovereignty and children's day. Therefore, we decided to include an activity, which consists of the children of the world, their clothes, favorite dishes, and the games played around the world. We added a little bit of geography. While we included explanations about how you should play the games, we also added QR codes for YouTube videos.

We continue diligently to do our best these current circumstances and we hope to meet your expectations. Thank you!

DCA Foreigner English Department



Some of The Games That Children Play All Around The World

Are you looking for around the world games to play with your kids and as a family? We have some fun for you!

1. Paper Dolls: Paper dolls are of Asian origin. Dolls became very popular in Europe in the 18th century. In America these dolls became popular in the 1800's and were popular for decades!



2. Bingo Game is of American origin. Bingo is often used as an instructional tool in American schools and in teaching English as a foreign language in many countries. Typically, the numbers are replaced with beginning reader words, pictures, or unsolved math problems.

3. Origami: Make Origami Paper boats! Origami is Japanese paper art that can be so much fun. You can create so many different things using this art.

4. Tangram: Tangram puzzles are dissecting puzzles. It originates in China back in the Song Dynasty and the word means seven board of skill.

They eventually made their way to Europe on trading ships in the 19th century and now these puzzles are enjoyed all over the world.



		<p>Popular Food: Bibimbap (mixed rice with spicy sauce, meat, and vegetables)</p>	<p>Population: 50 million</p>	<p>Capital City: Seoul</p>	<p>Üzümü: 2017ü Köle9</p>
Flag					

Paper Dolls Around the World: Asia XII

Color me and dress me up!
Can you guess what country I am from?

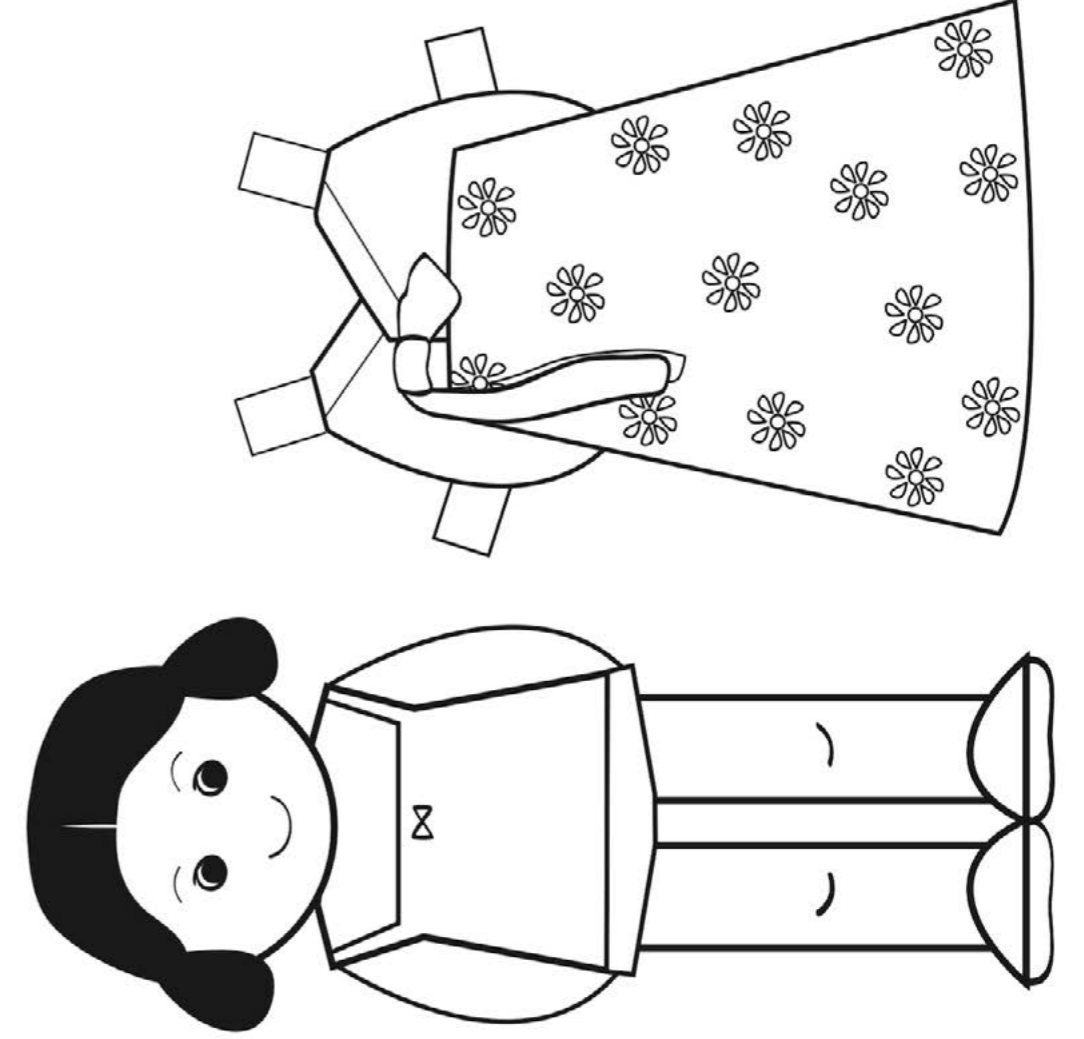

Paper Dolls Around the World: Europe VIII

Color me and dress me up!

Can you guess what country I am from?

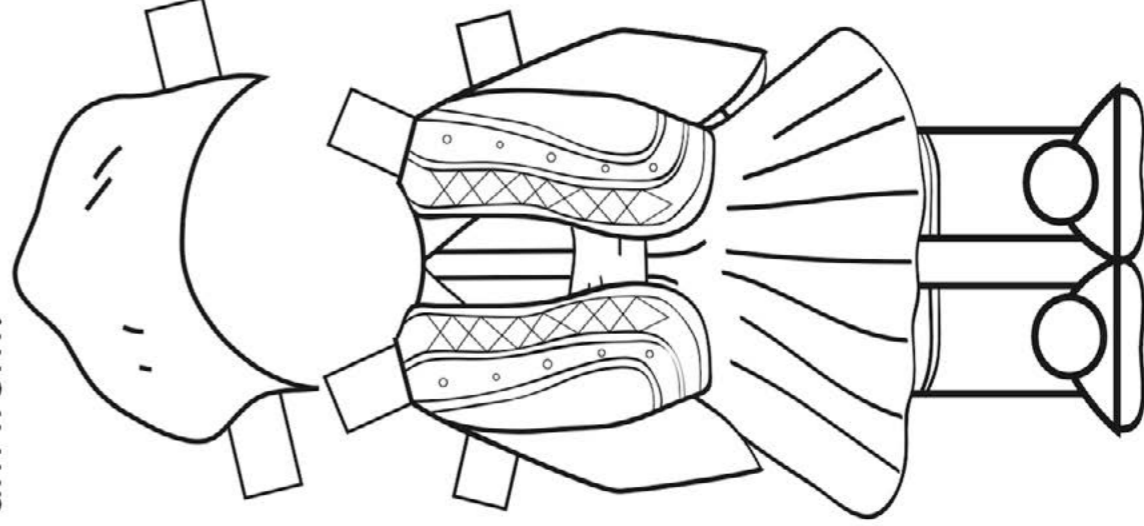
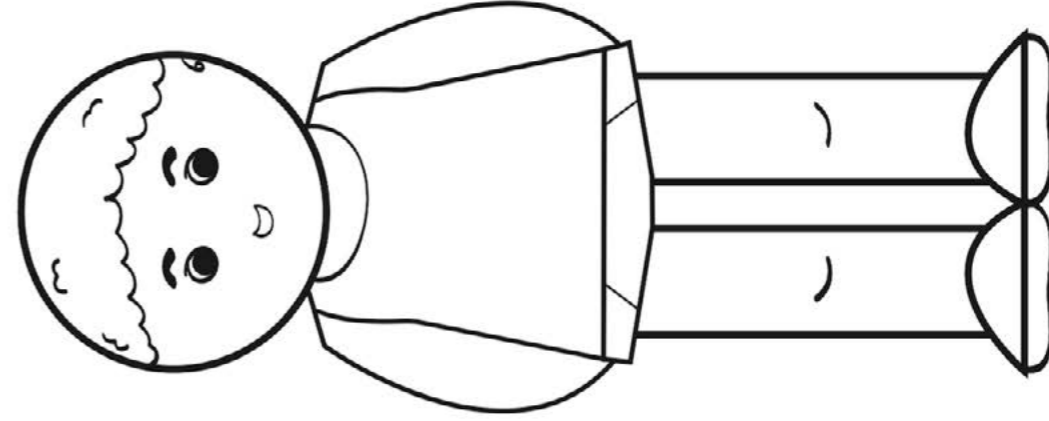

Flag

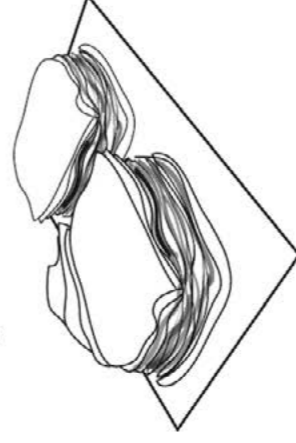

Popular Food: Spanakopita
(Spinach pie)

Population: 11 Million

Capital City: Athens

Αυστρωλ : ΓΙΕΡΕΣΣ

Paper Dolls Around the World: Asia I

Color me and dress me up!

Can you guess what country I am from?

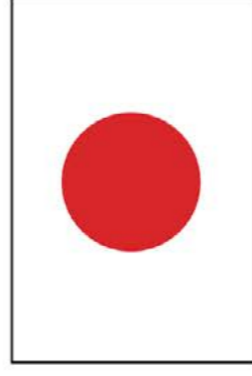
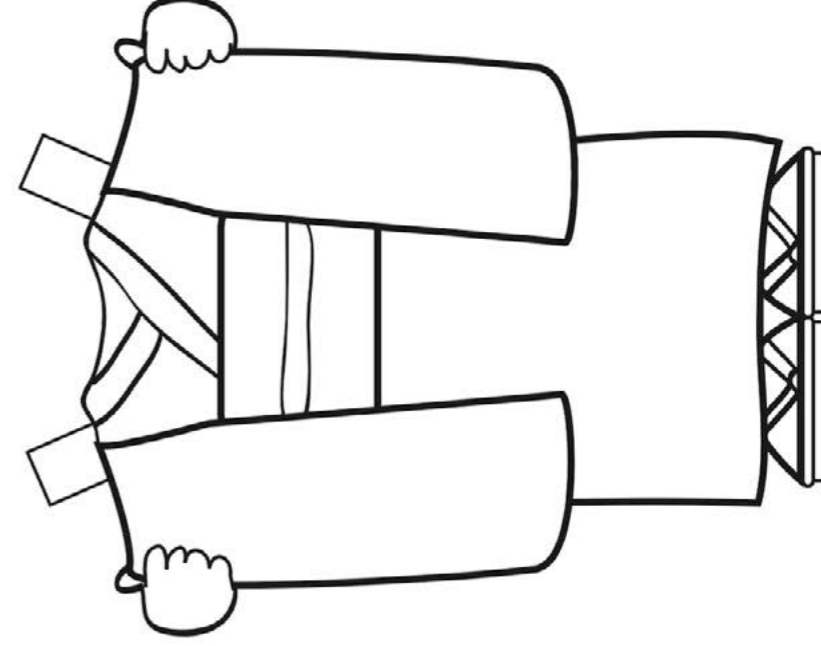
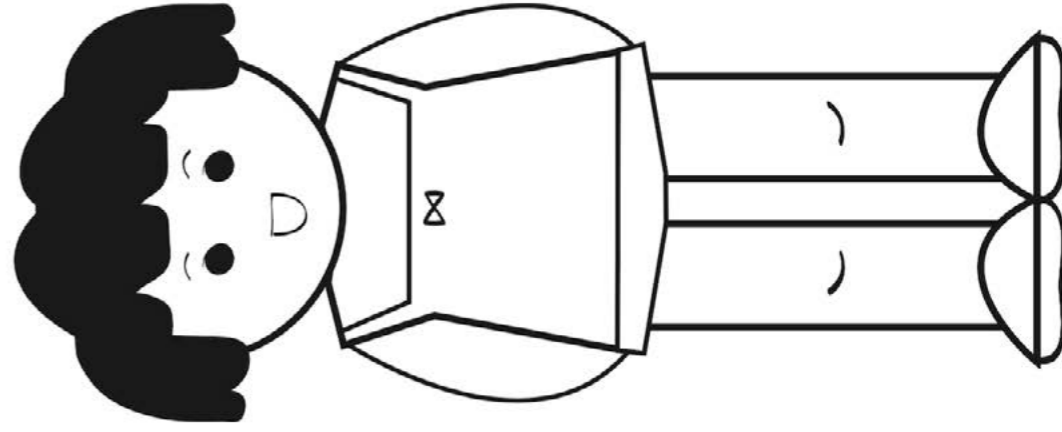

Flag

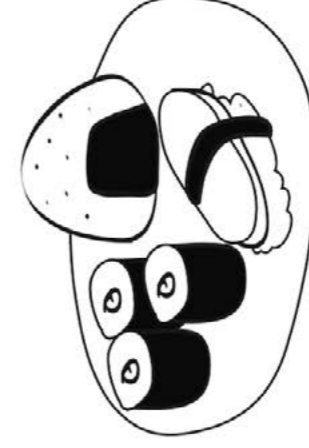

Popular Food: Sushi

Population: 127 Million

Capital City: Tokyo

تۇزىمى : ۱۲۷مىلىيۇن

Paper Dolls Around the World: Europe XII

Color me and dress me up!

Can you guess what country I am from?

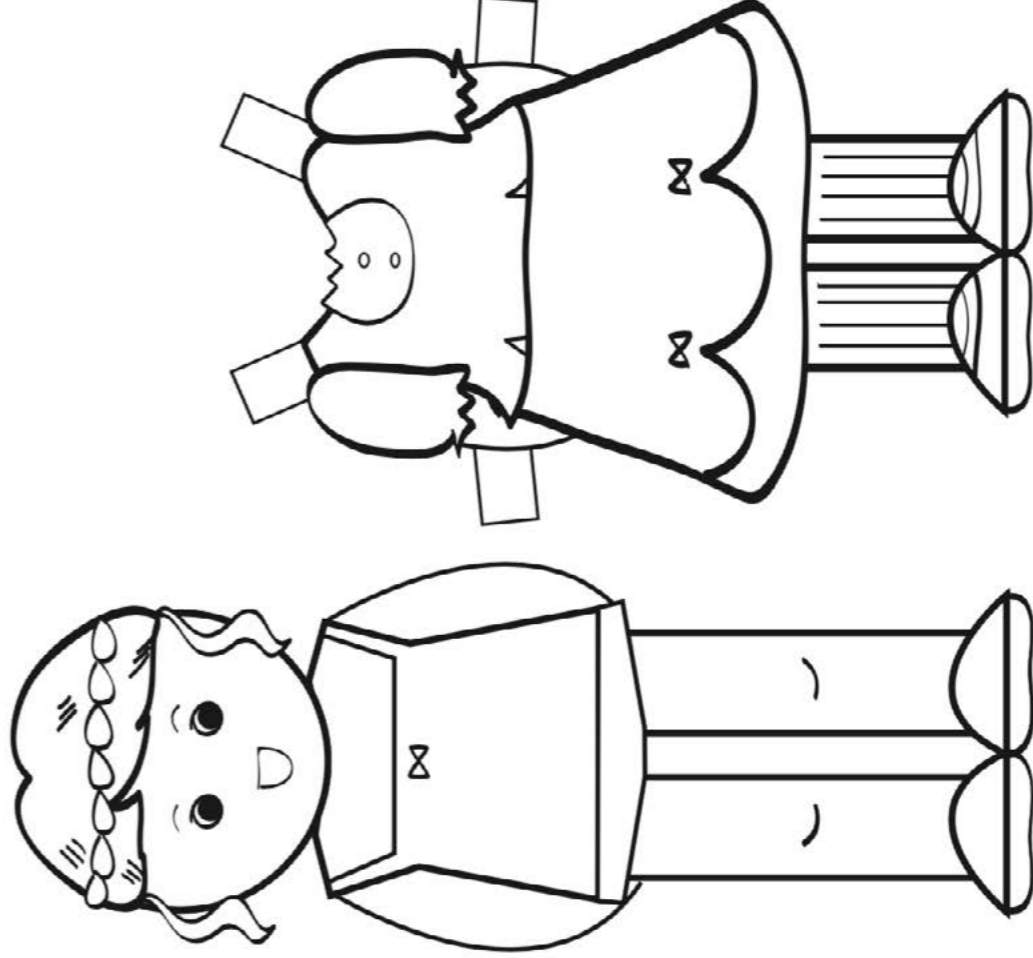

Flag



Popular Food: Fondue

Population: 7.7 Million

Capital City: Bern

buwmer: 2wifzehsyug

Paper Dolls Around the World: Asia IV

Color me and dress me up!

Can you guess what country I am from?

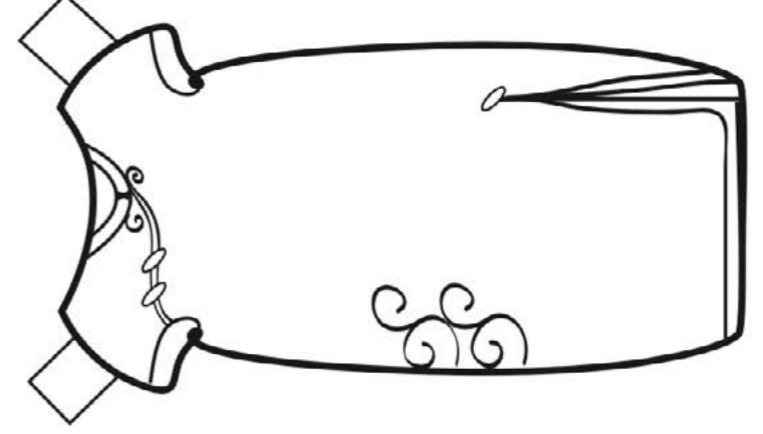
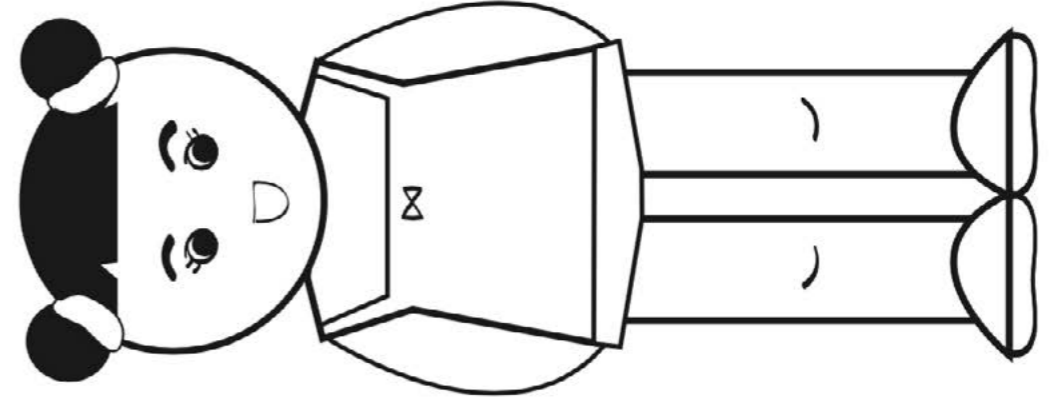

Flag



Popular Food: La mian
(Hand-pulled noodles)

Population: 1.3 Billion

Capital City: Beijing

Answer: China

Paper Dolls Around the World: Asia V

Color me and dress me up!

Can you guess what country I am from?

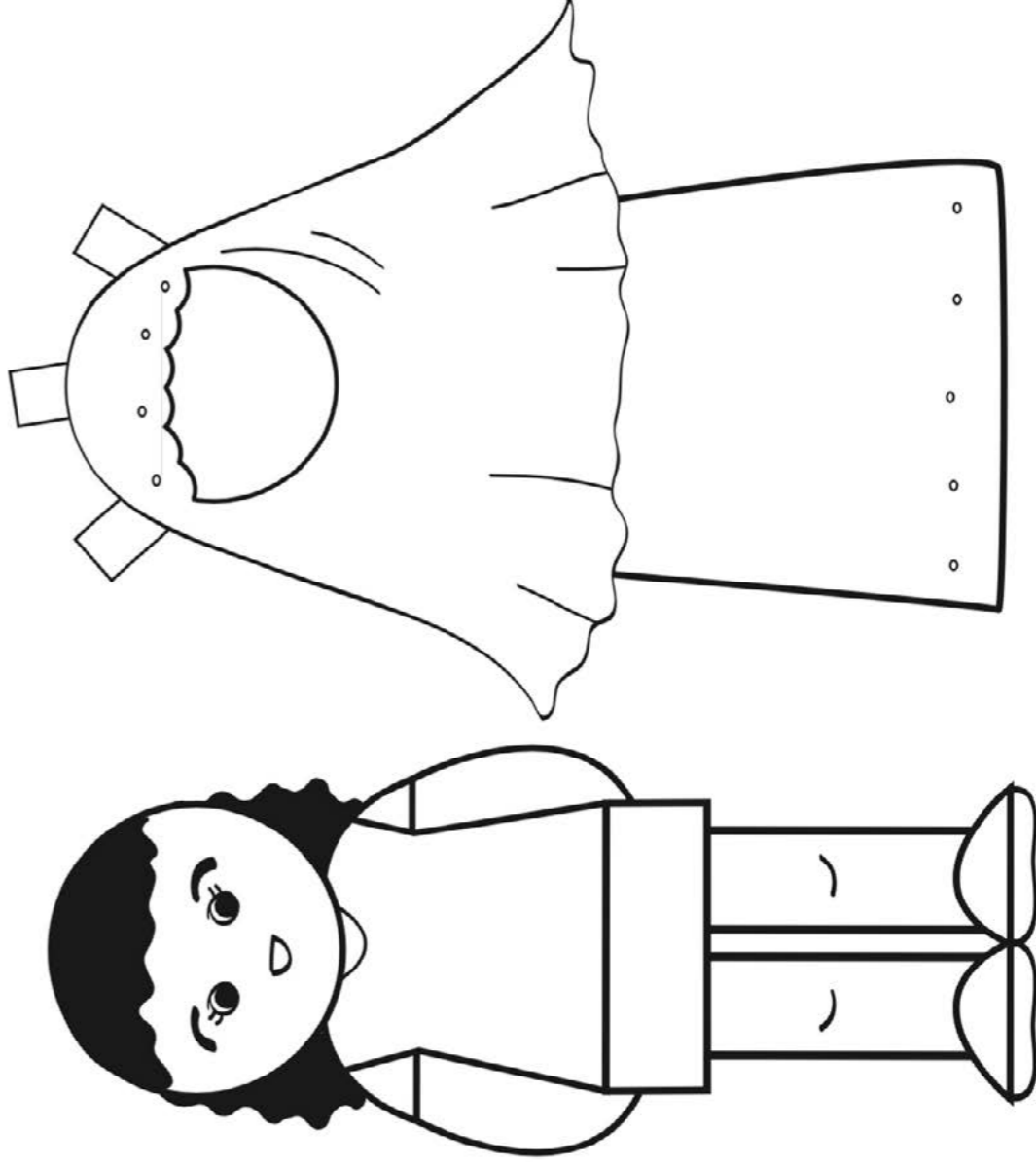

Flag

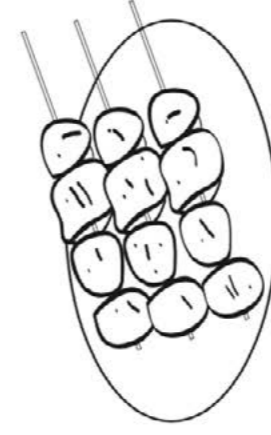

Popular Food: Kebab

Population: 74 Million

Capital City: Tehran

1611 :19w2nA

CONTINENTS (Tell The Name Of The Continent And Color)

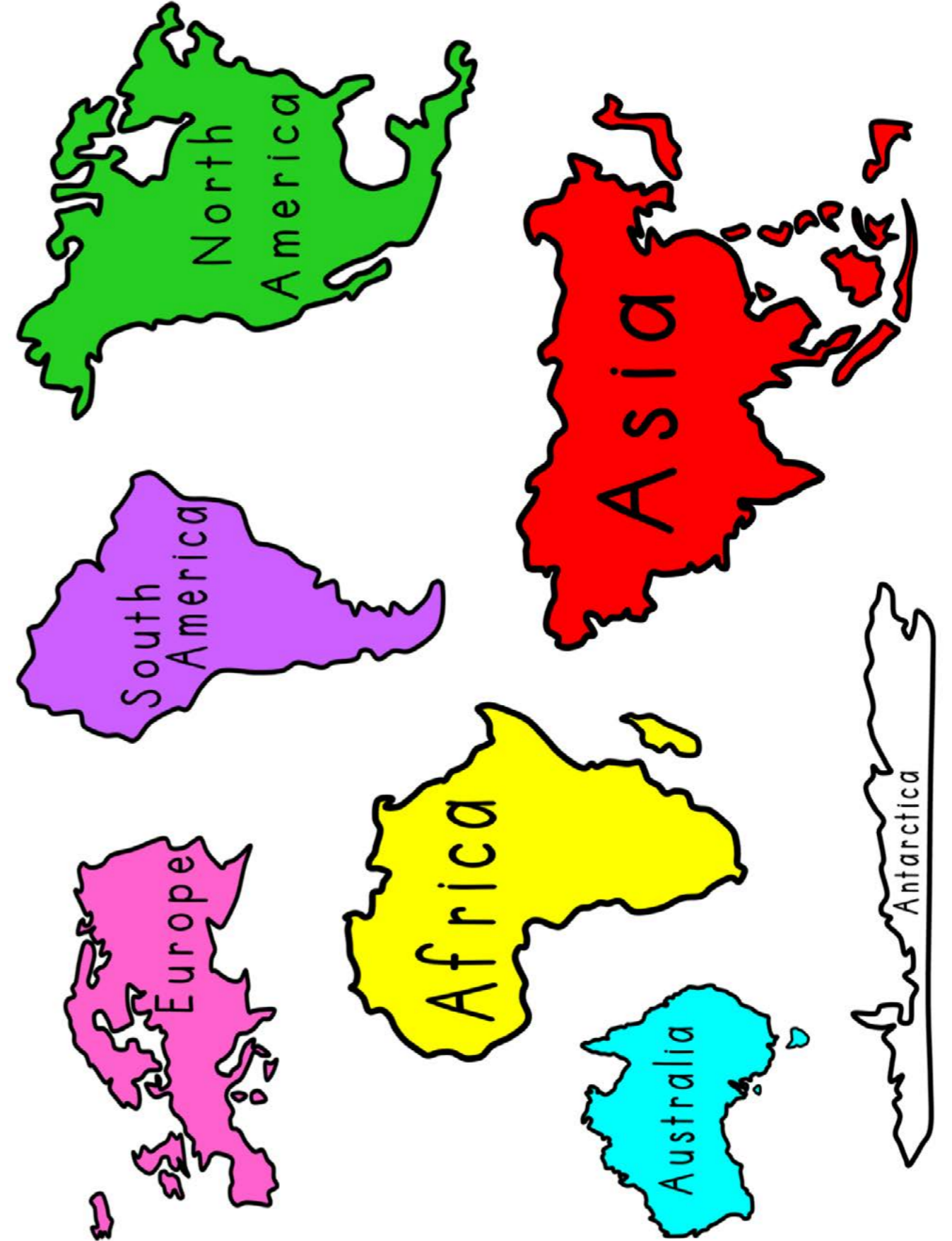



FLAG BINGO GAME!

When you see a flag card matching one below, say the name of the country and claim the flag. Maximum 4 people can play this game.

 Greece	 France	 Sweden	 Brazil
 China	 India	 Canada	 Argentina
 South Korea	 Netherlands	 Australia	 Belgium
 United Kingdom	 South Africa	 Japan	 United States of America

FLAG CARDS TO CUT



SHAPES FOR TANGRAM GAME



Trapezium

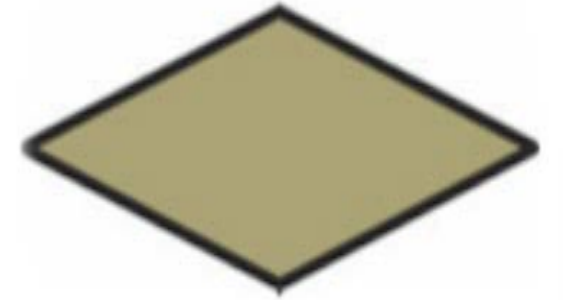

Tetragon

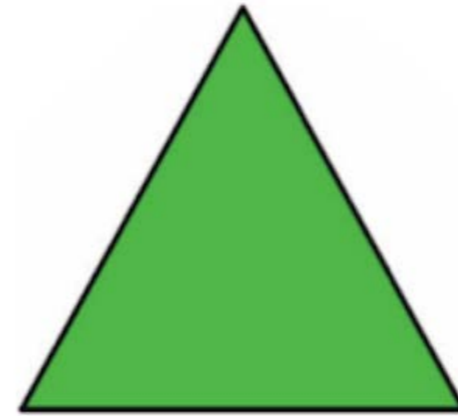

Triangle

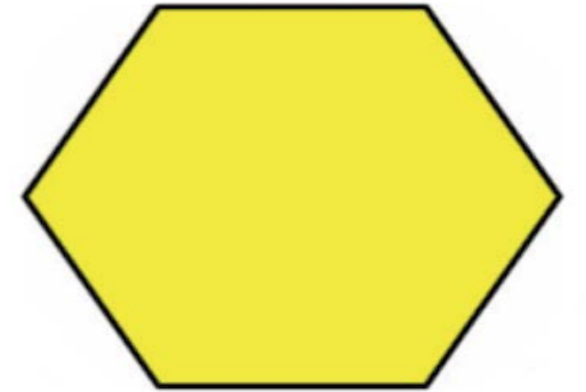

Hexagon



Diamond



SquarE

CAN YOU MAKE A CRAB?

I can make a crab.

Which picture is different?

Mark each shape that you used.

CAN YOU MAKE A FISH?

I can make a fish.

Which picture is different?

Mark each shape that you used.

Which picture is different?

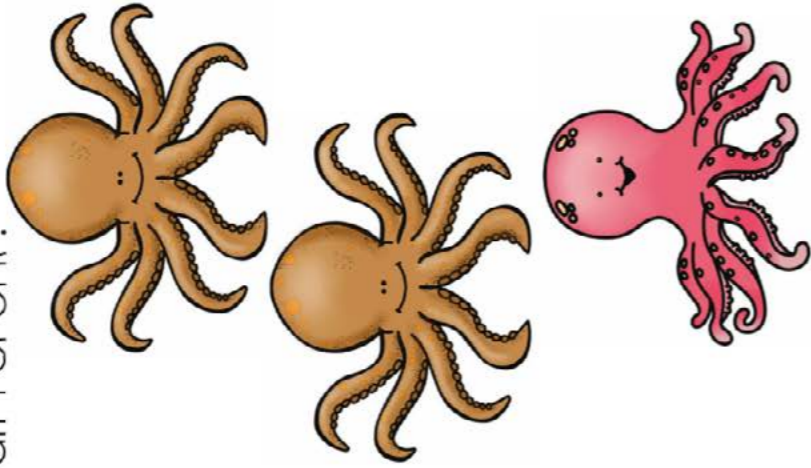

CAN YOU MAKE AN OCTOPUS?

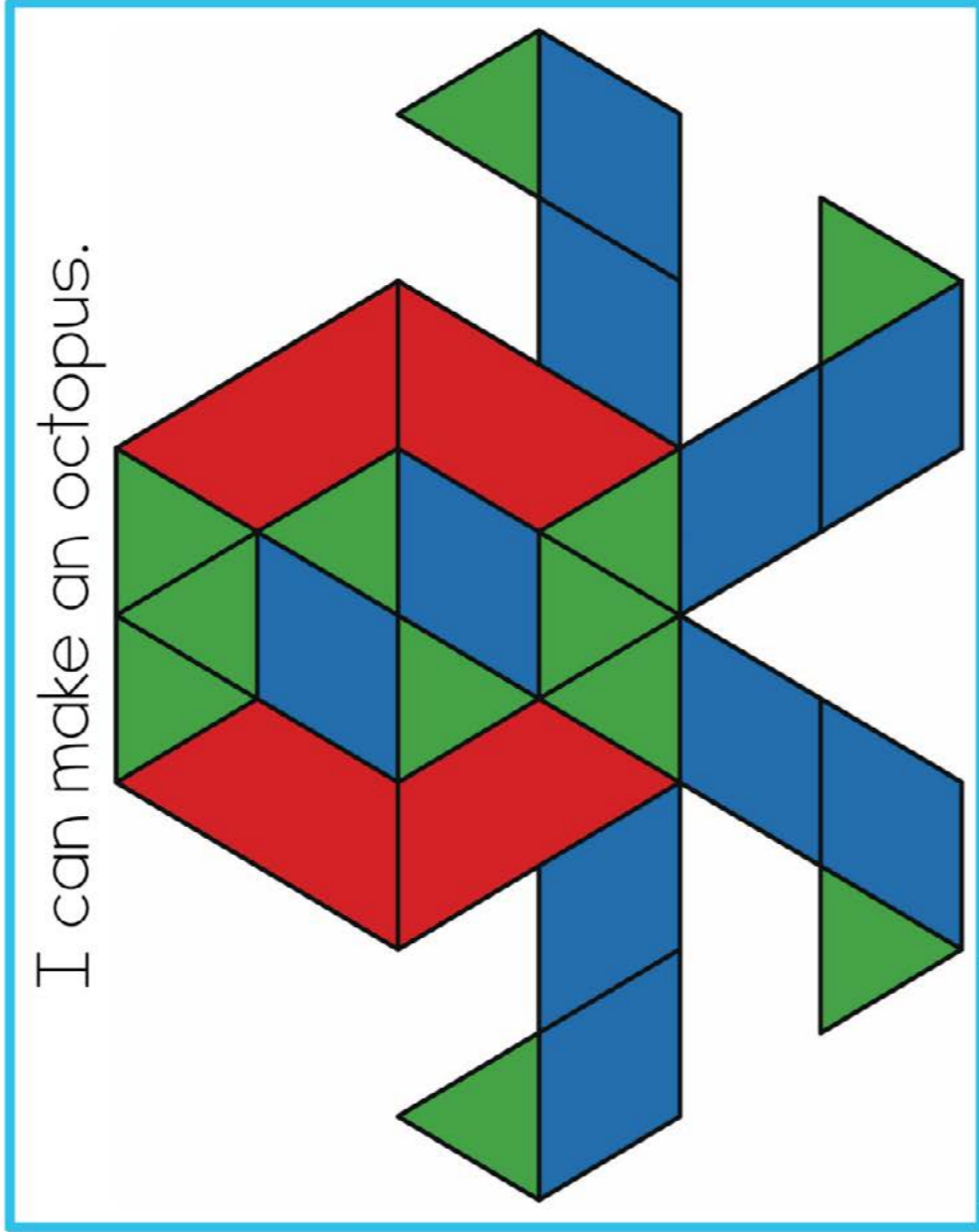

Mark each shape that you used.

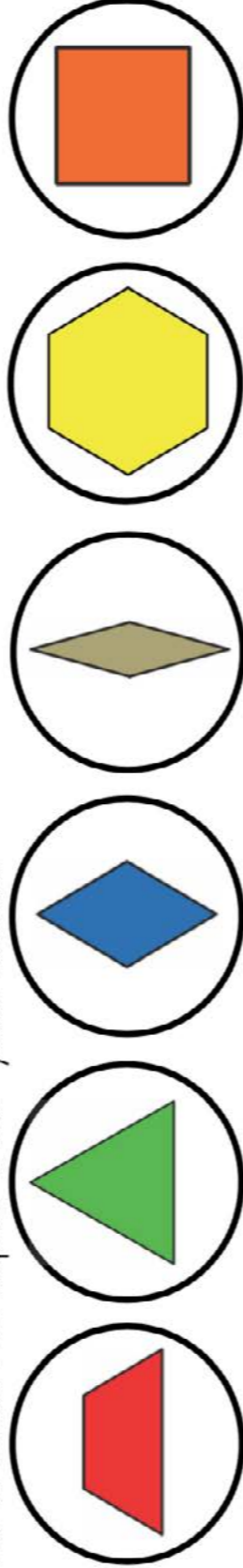

Which picture is different?

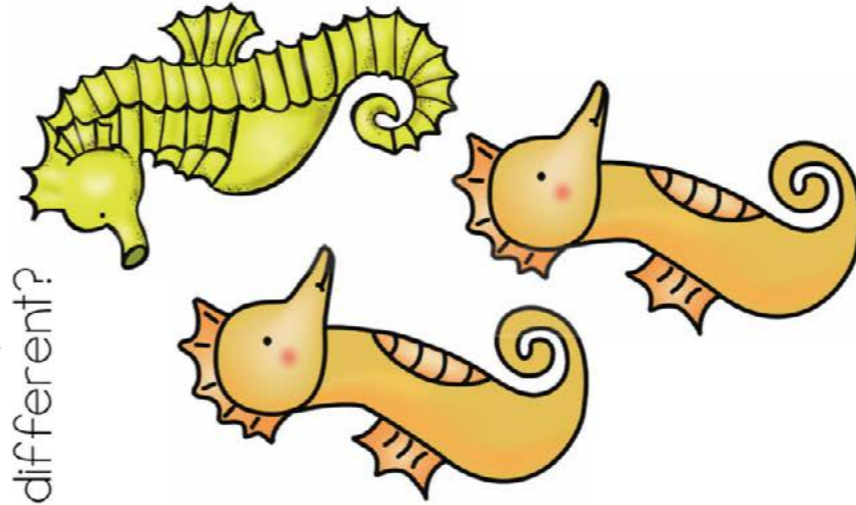

CAN YOU MAKE A SEAHORSE?

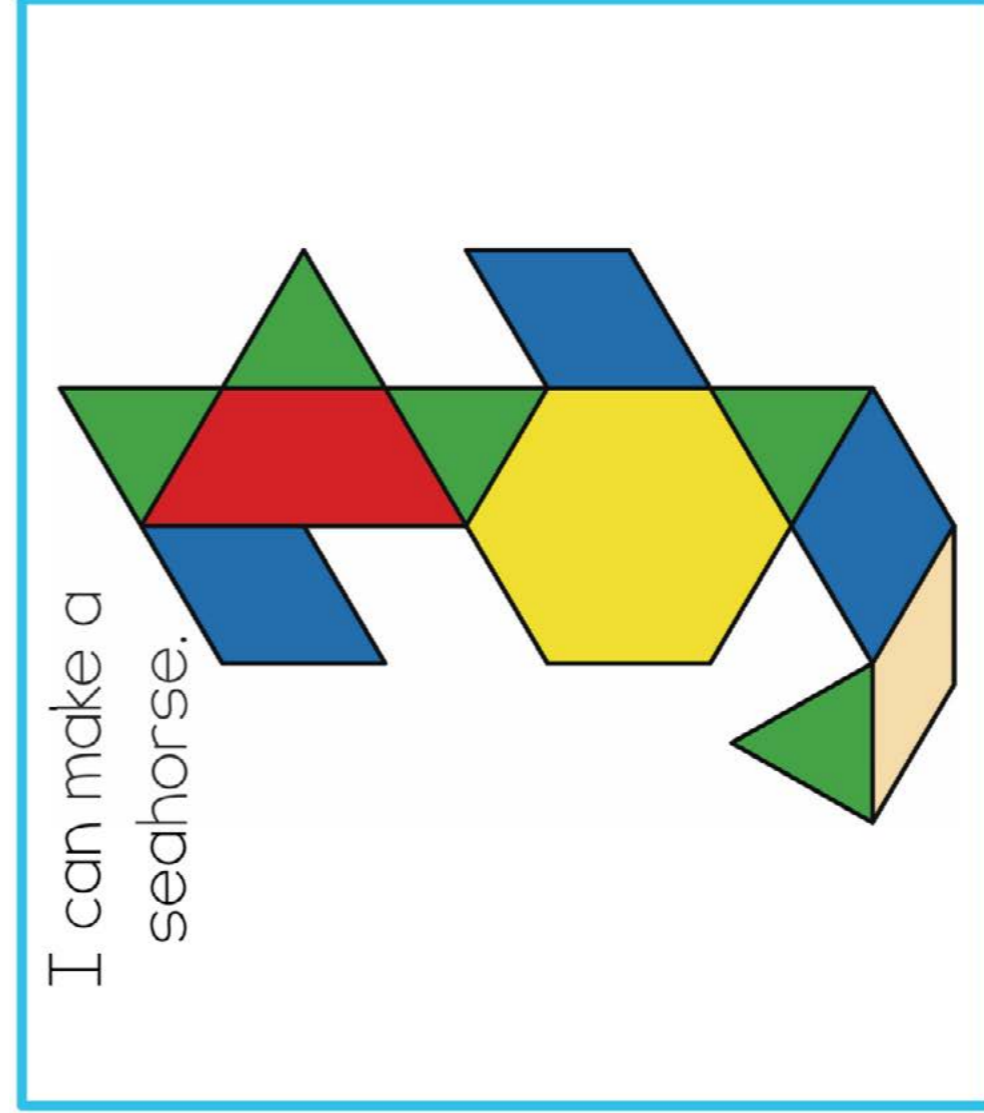

Mark each shape that you used.

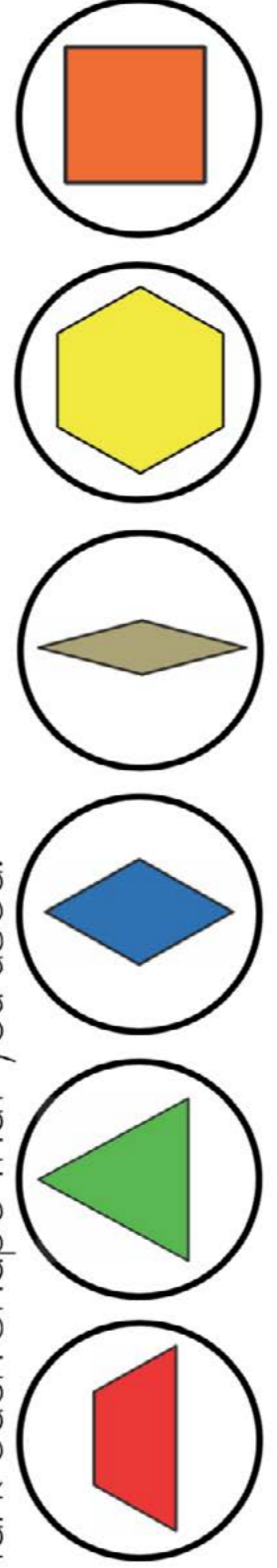

ORIGAMI BOAT RACE

Summary: Teach children how to make an origami boat- and then race them.

Goal: See whose origami boats can reach the end the quickest.

Preparation:

- Blank pieces of standard printer paper
- Straws (a straw per person)
- Large plastic tub filled with water
- Markers

How to Play the Origami Boat Race:

1. Hand everyone a piece of paper. Teach everyone how to fold an origami boat (instructions are on the next page).
2. After everyone folds their paper boats, have them name and decorate their boats.
3. Have two volunteers to race their boats. Place both boats on one side of the tub. When you say “go”, have them use the straw to blow their boats to the other side of the tub.



ORIGAMI PAPER BOAT

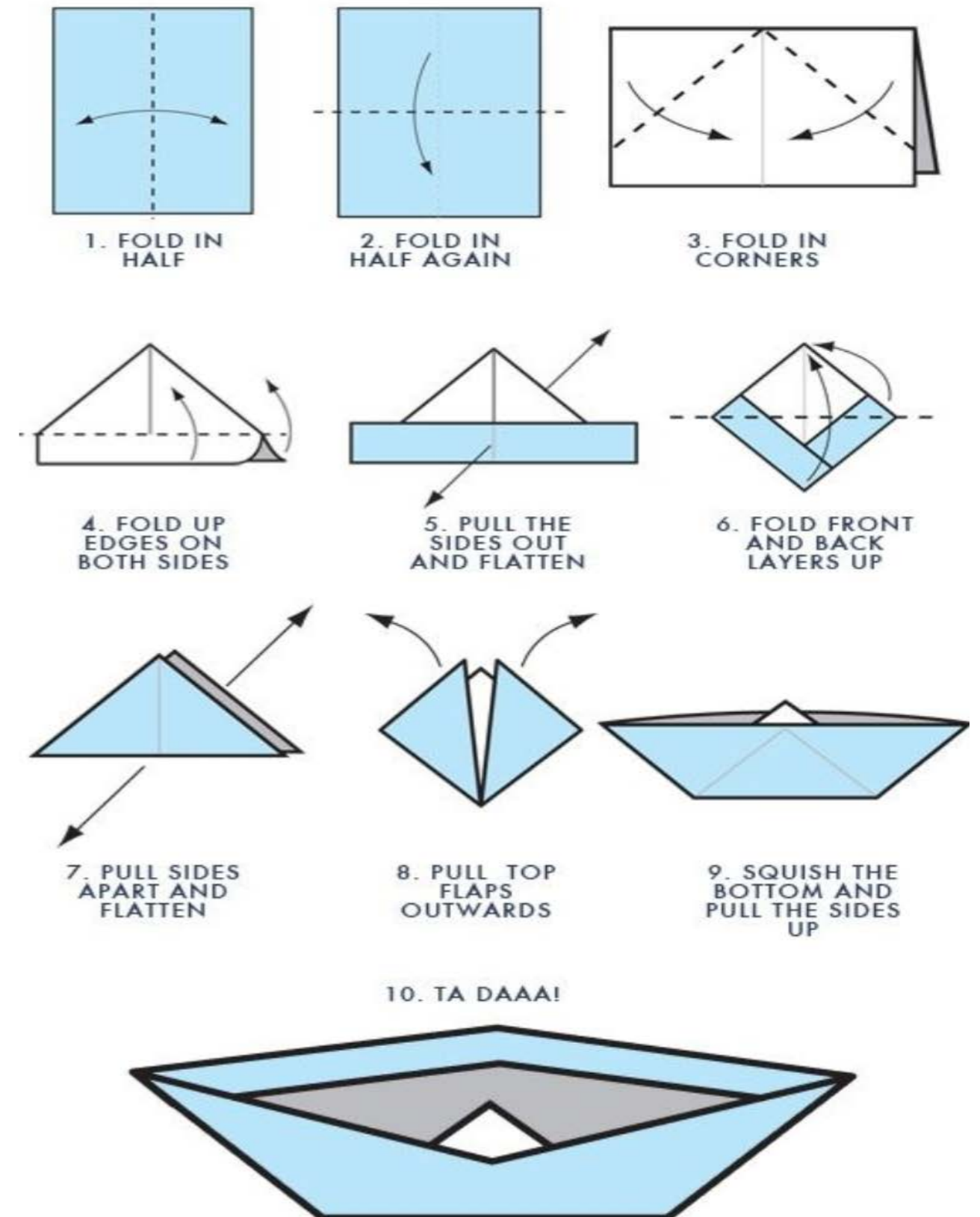



www.dcamaslak.com

@dcamaslak

