



**Dünya Çocuk
Akademisi**
Ağaoğlu Maslak 1453

**4//ENJOY IT
TOGETHER**



Number 9

BİZ KOÇAMAN BİR AİLEYİZ...



#zorluklarberaberasilir

#oncemoral

#guzelruhhali

#onceinsan

#COCUGUNGUCU

#OGRENMENIN GUCU

#OGRETMENINVARLIGI

#EGITIMOLMADANASLA

Our dear parents

We spent so many weeks together and now we want to say that we appreciate you because of your feedback.

Each of your loving messages and the photos which you shared with us is the double motivation for us in these days...

So please accept our warm thanks.

This week we are going to talk about vehicles and teach our children that what is the disability ! cause as you know this week is named: "Disability week", Disability Week 2020 in Turkey begins on Sunday, May 10 and ends on Saturday, May 16

DCA Foreigner English Department

Today we are going to learn about **Vehicles**.

A vehicle is a machine that transports people or cargo.

Generally, vehicles sort into four categories:

* Air Rail Road Water *

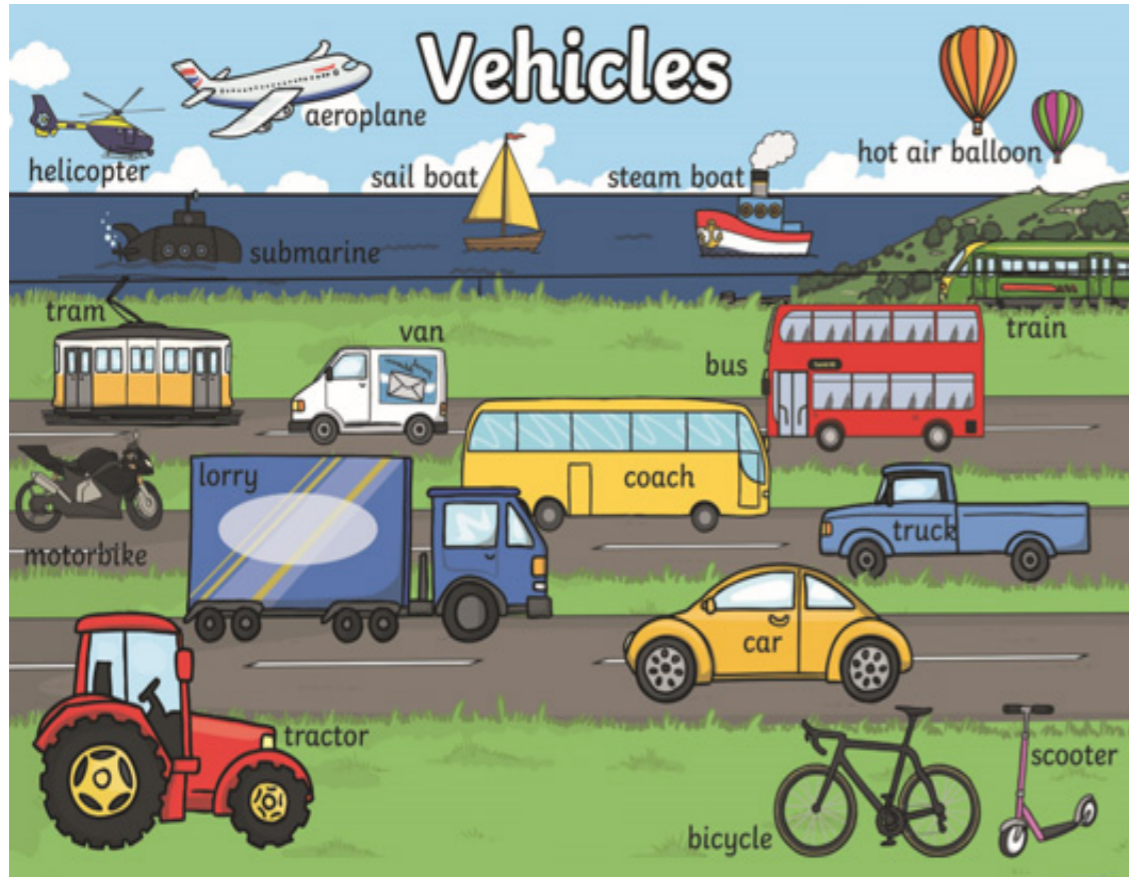

Now please look at the pictures carefully and repeat the words.

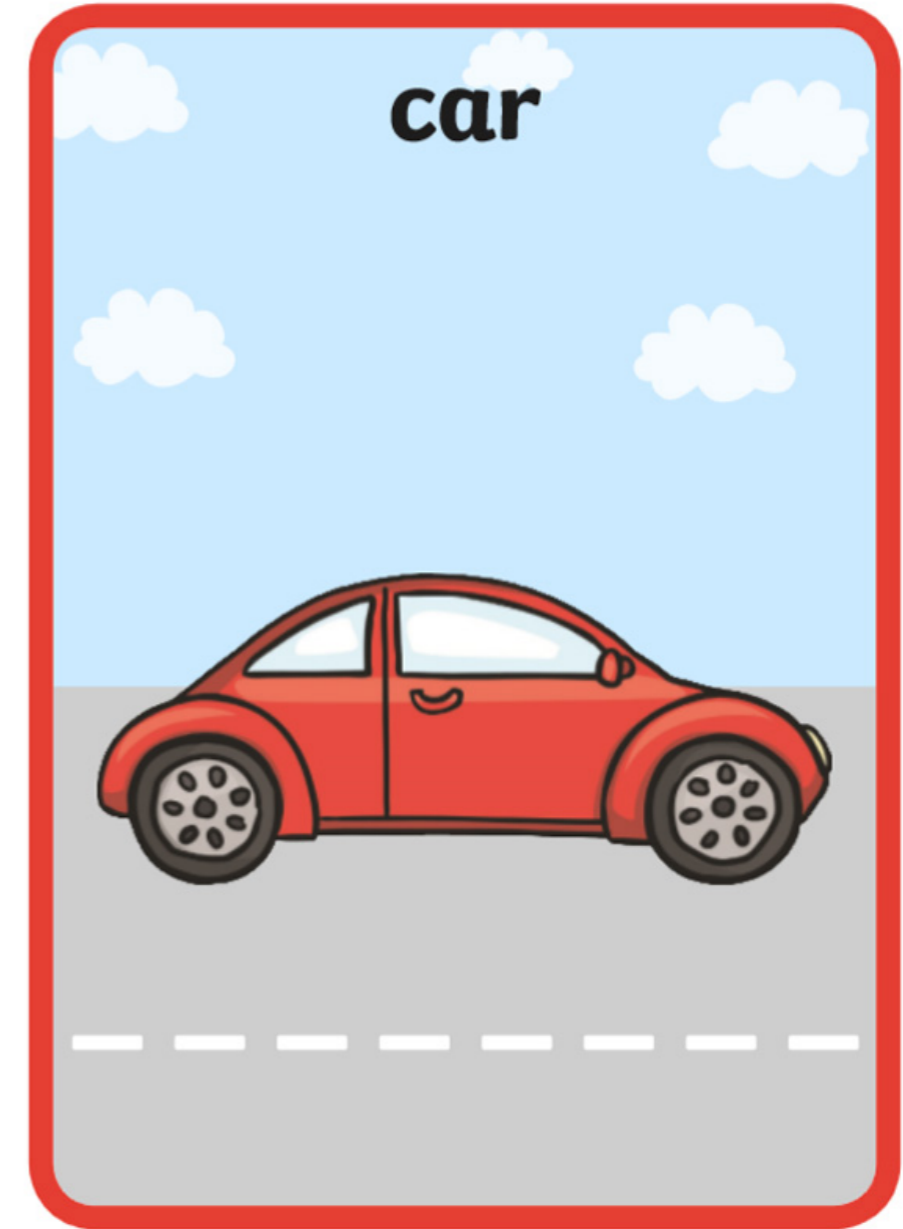

bus



lorry



train



tram

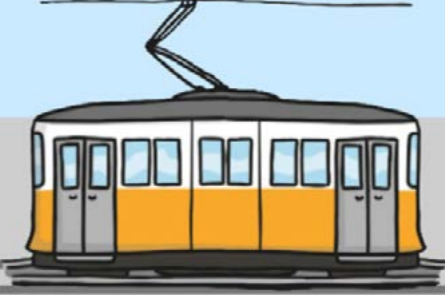

truck



van



steam train



tractor



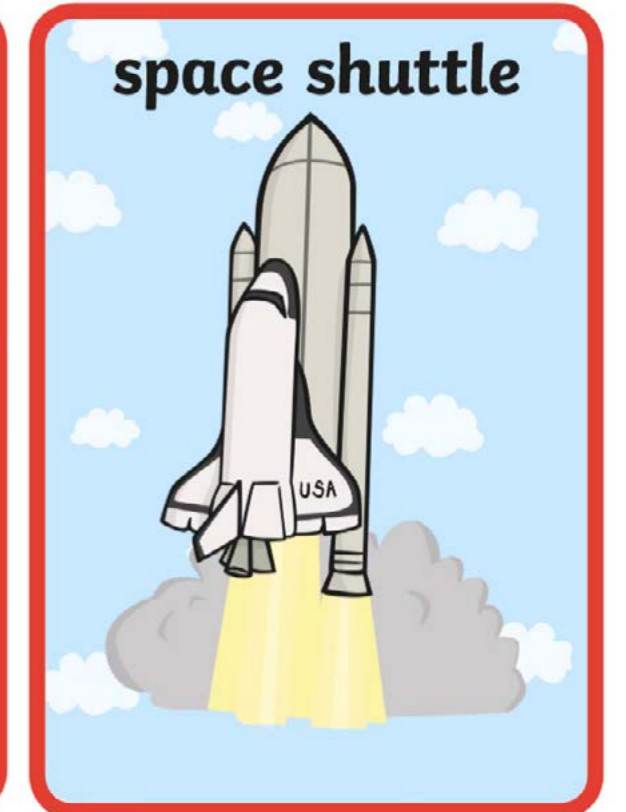
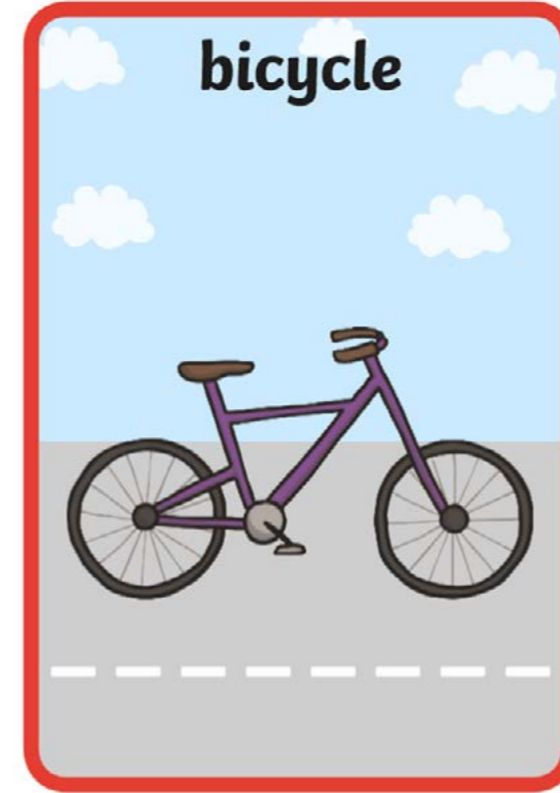
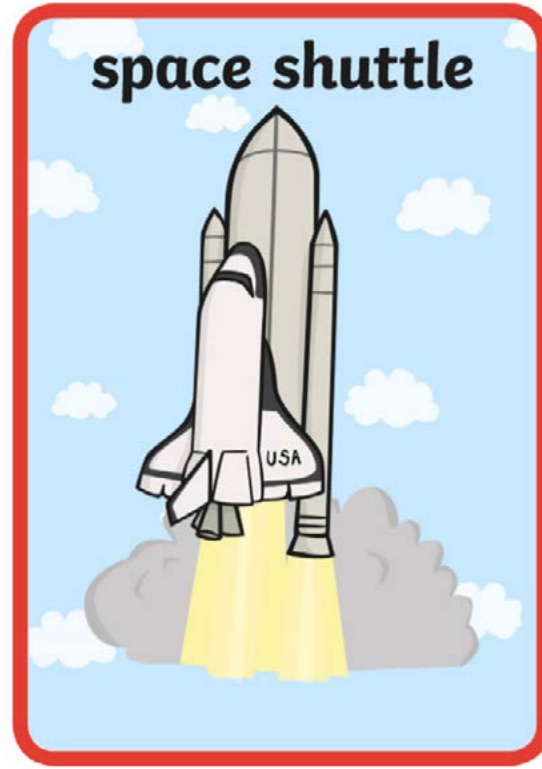

submarine

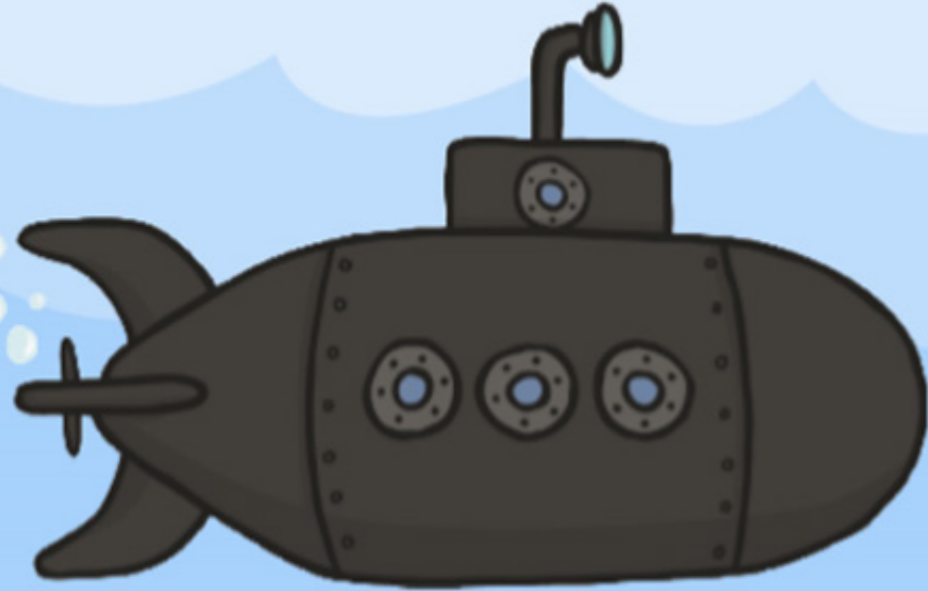

Now it is coloring time

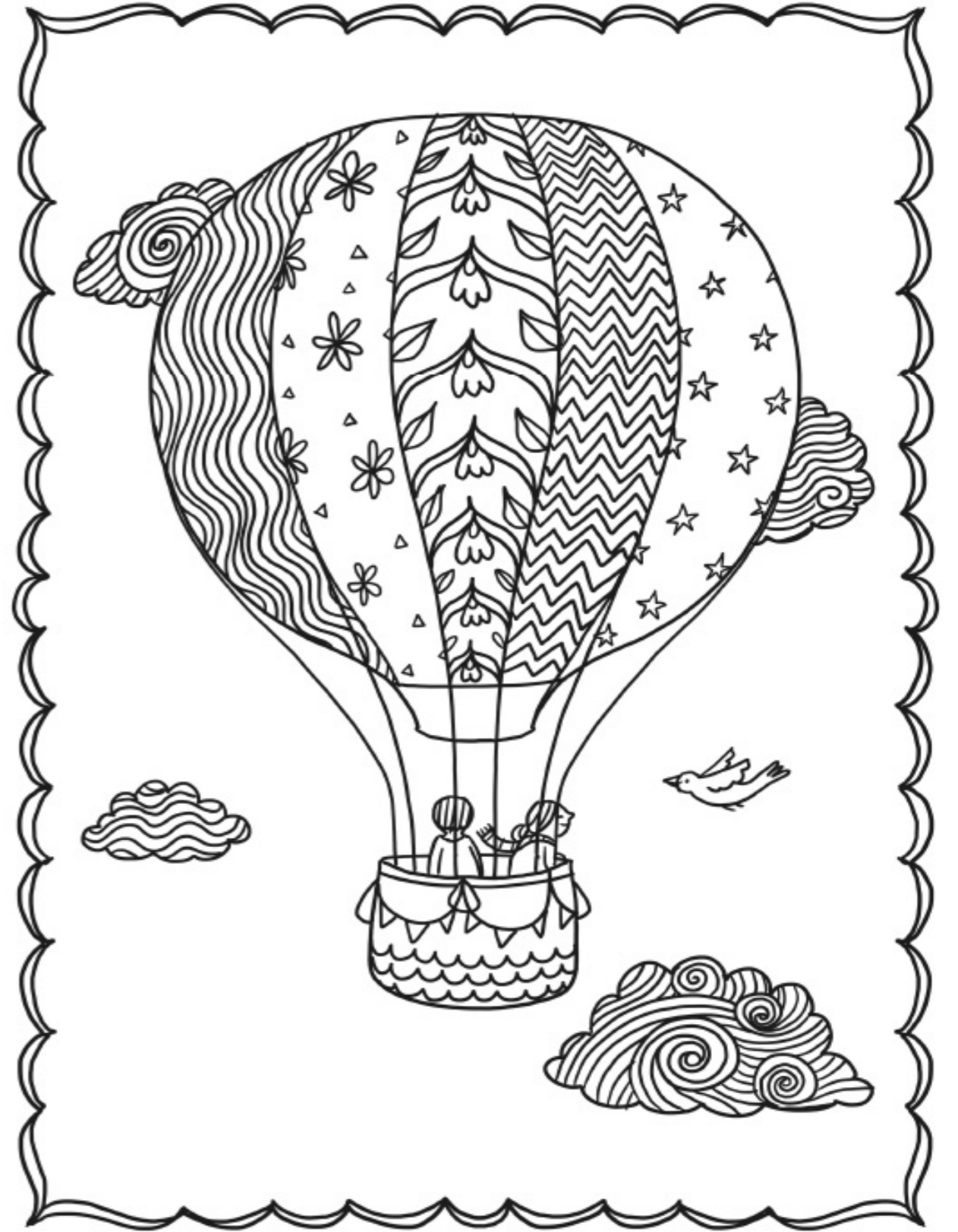

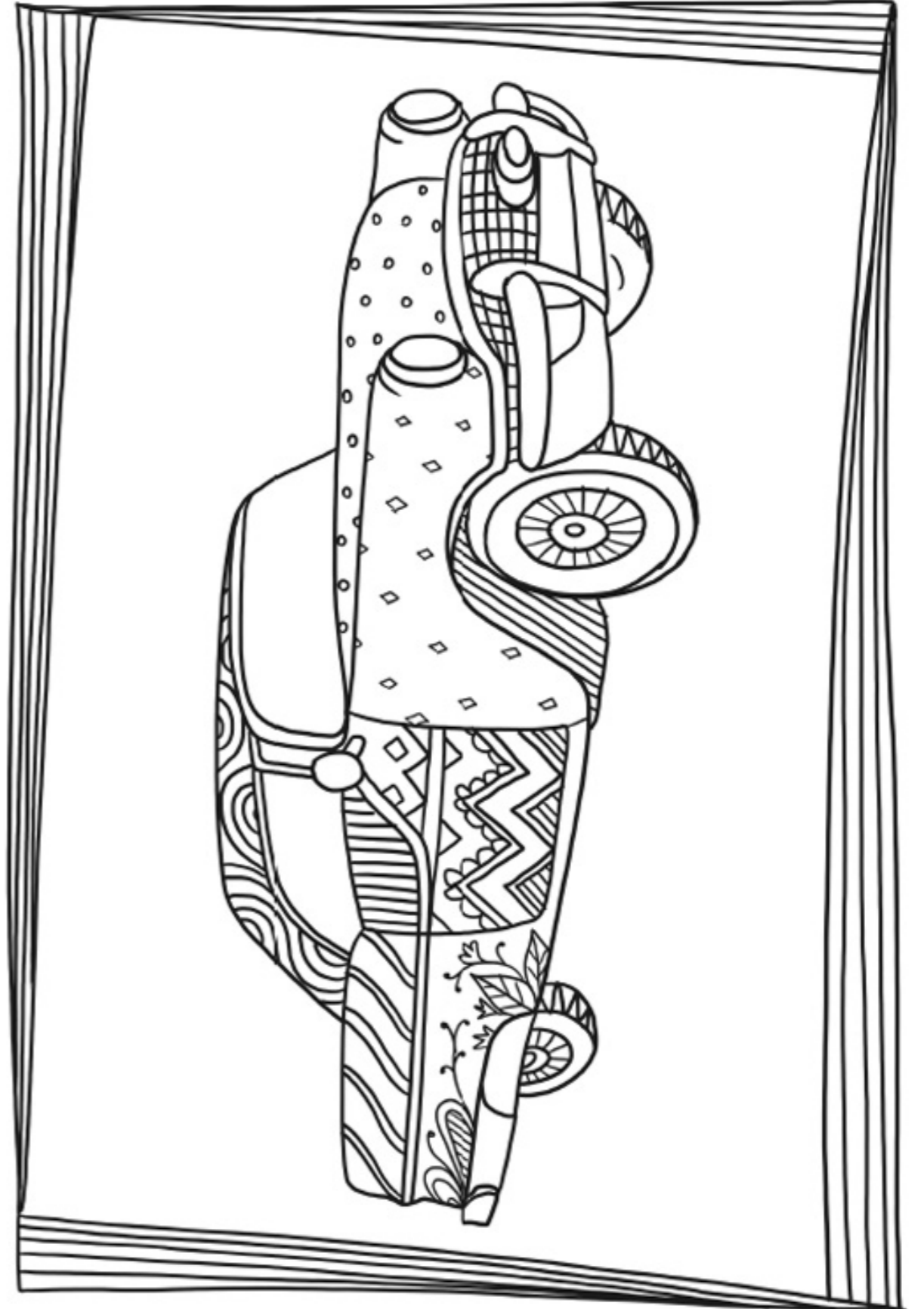

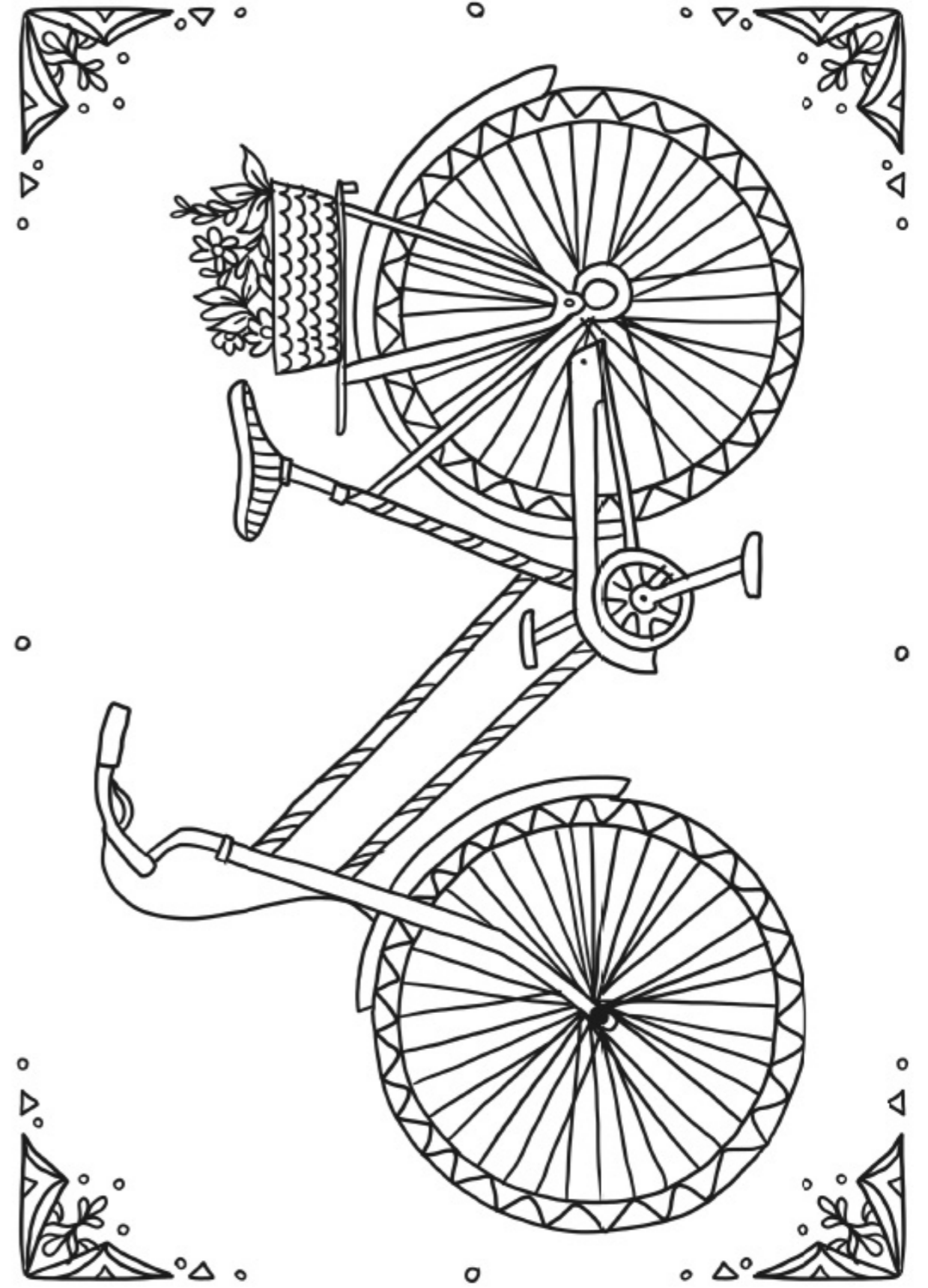
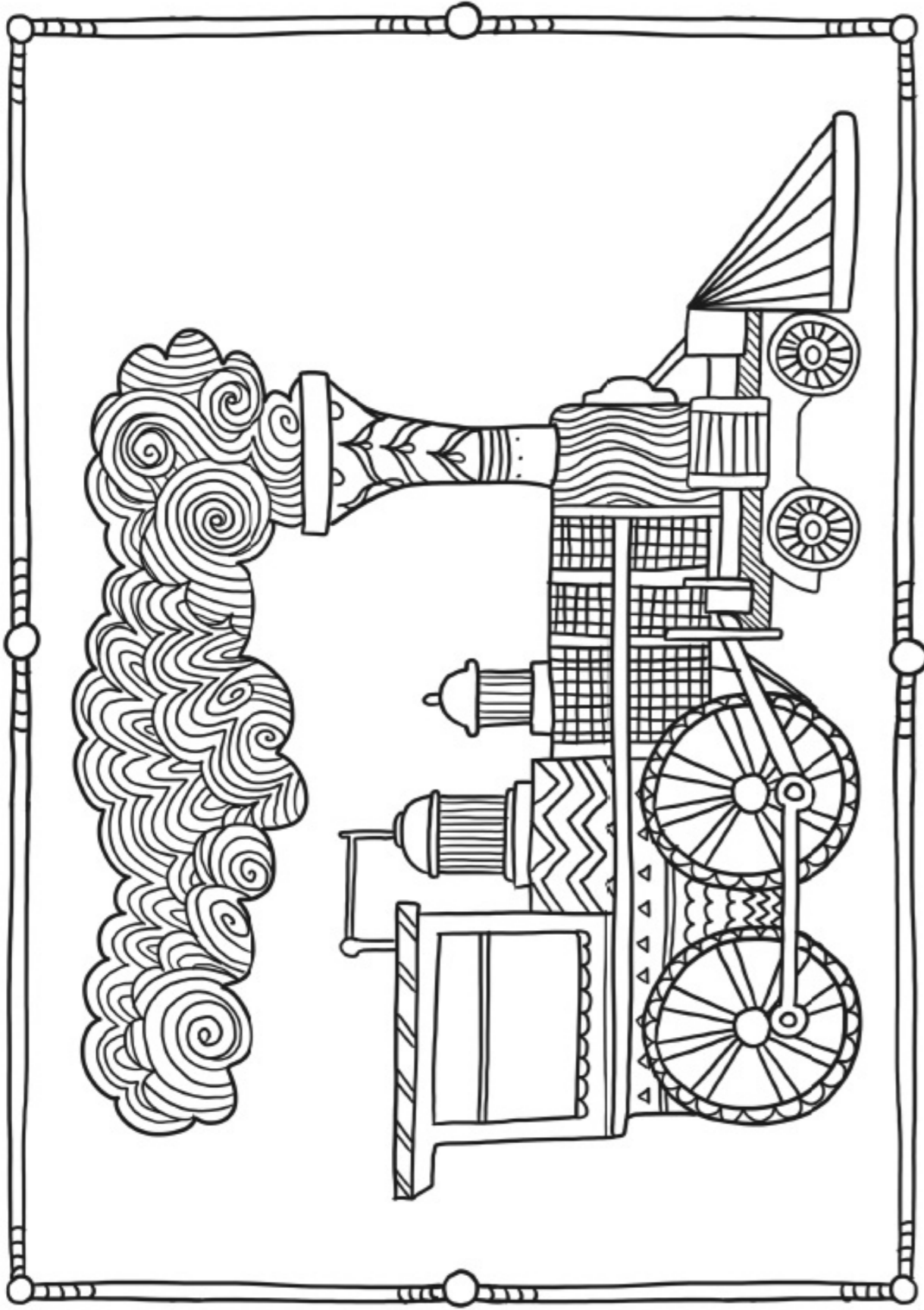

Follow the line with your vehicle

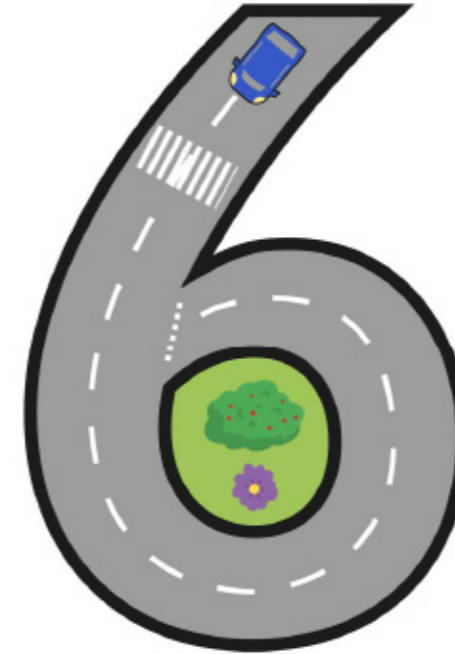
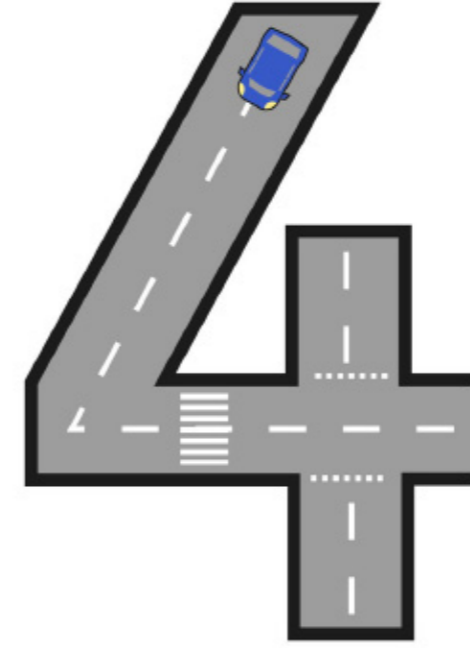
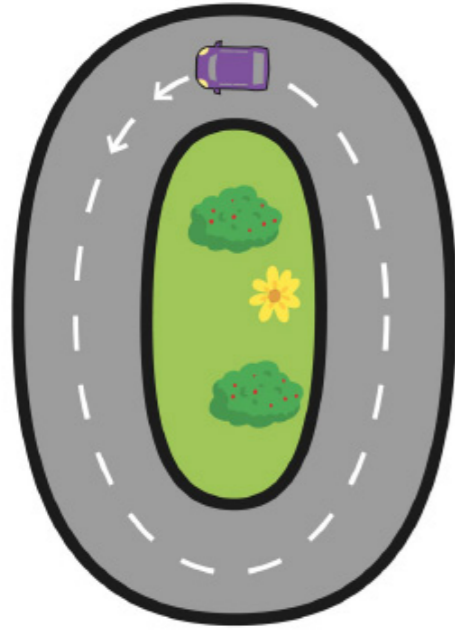

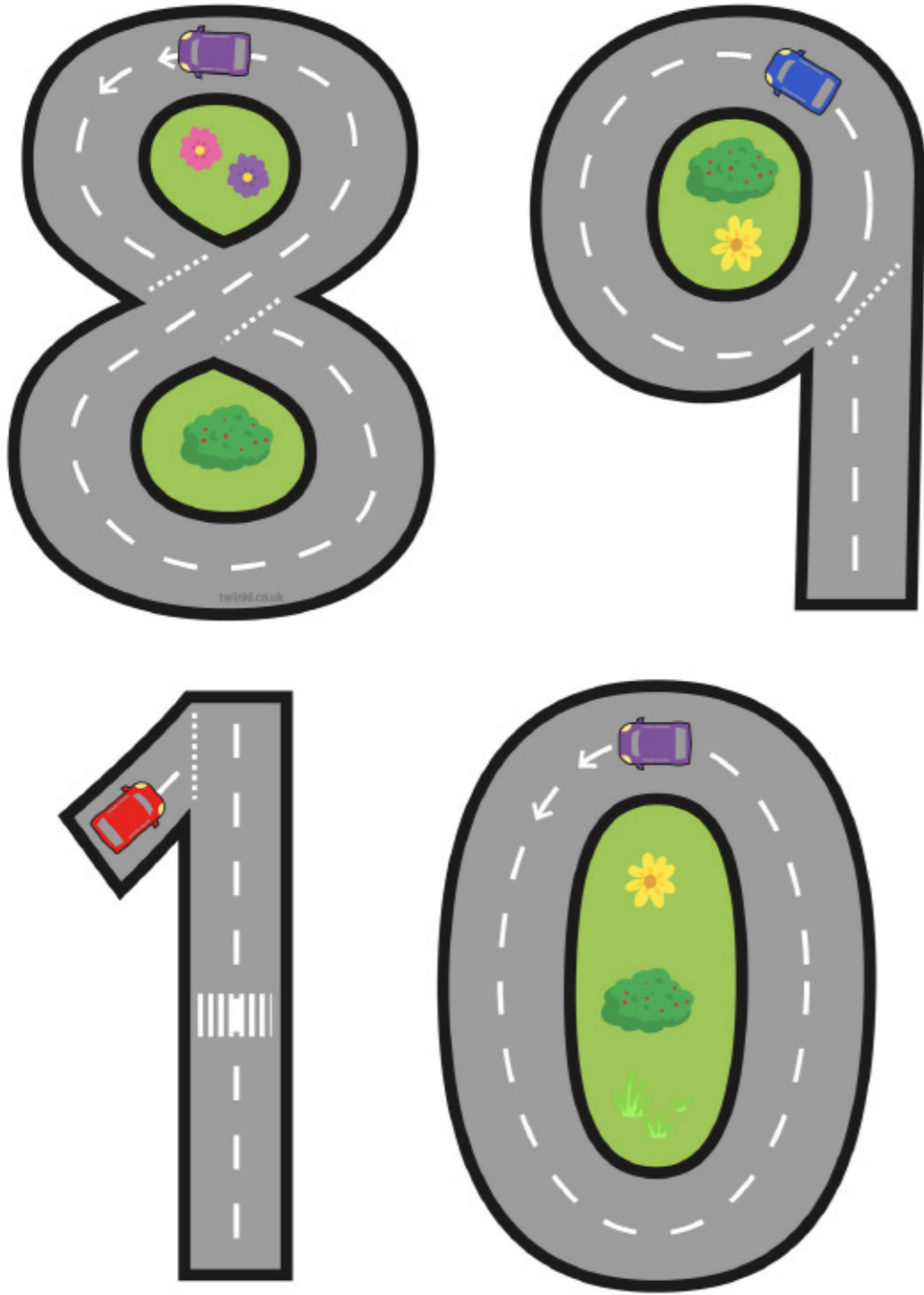

tracing activity

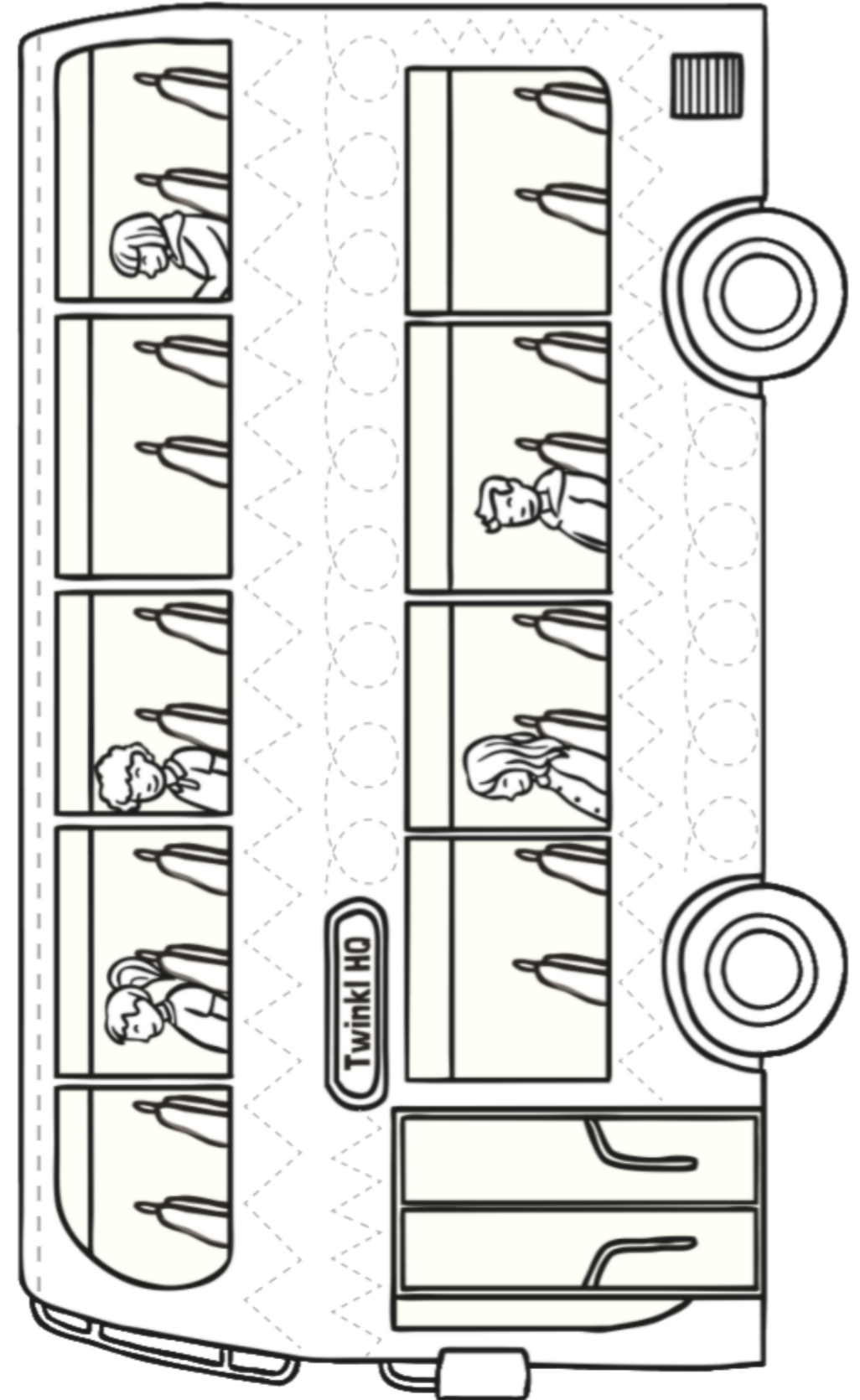

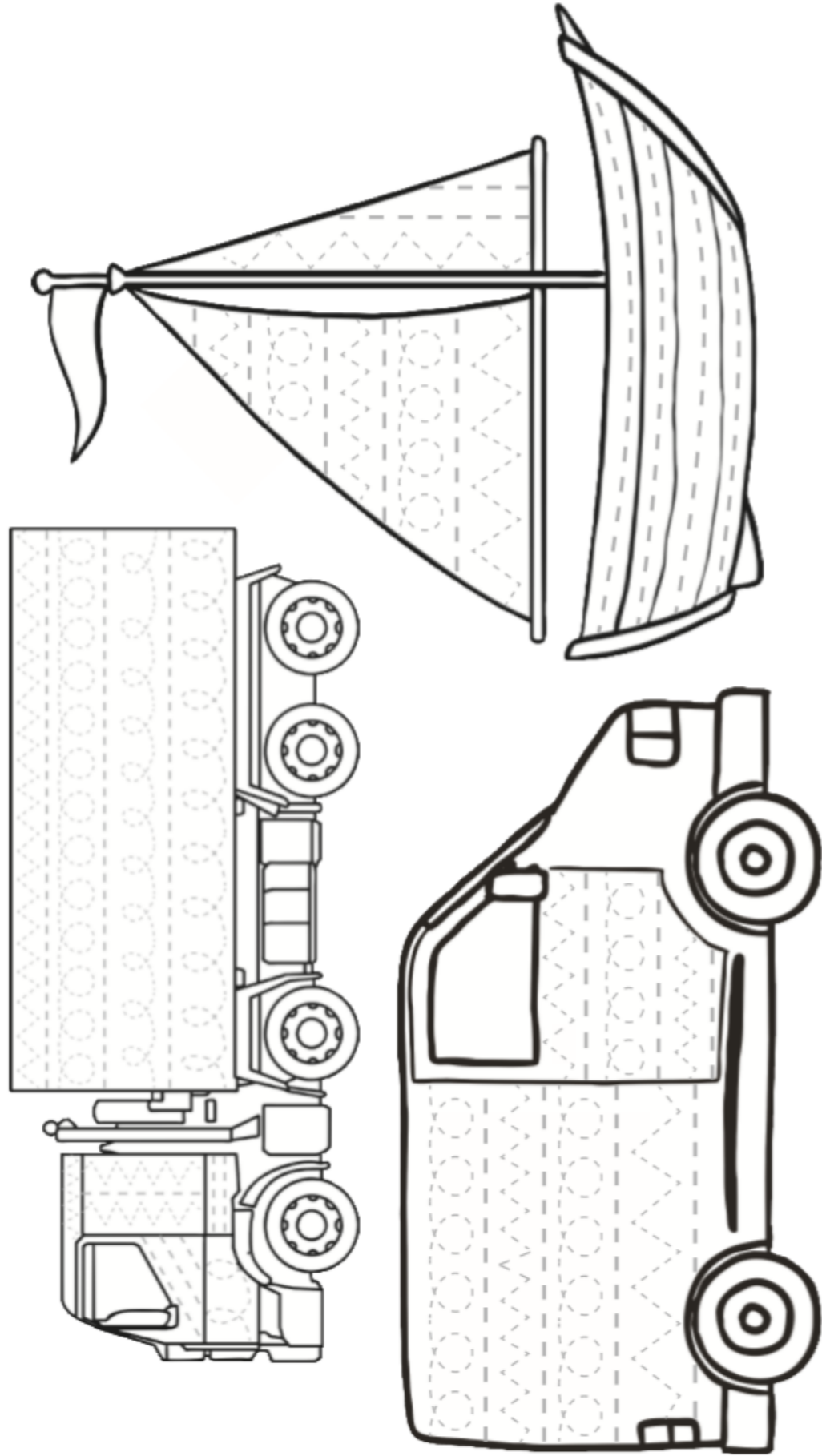

Now play this songs
and then start to make an ambulance with paper



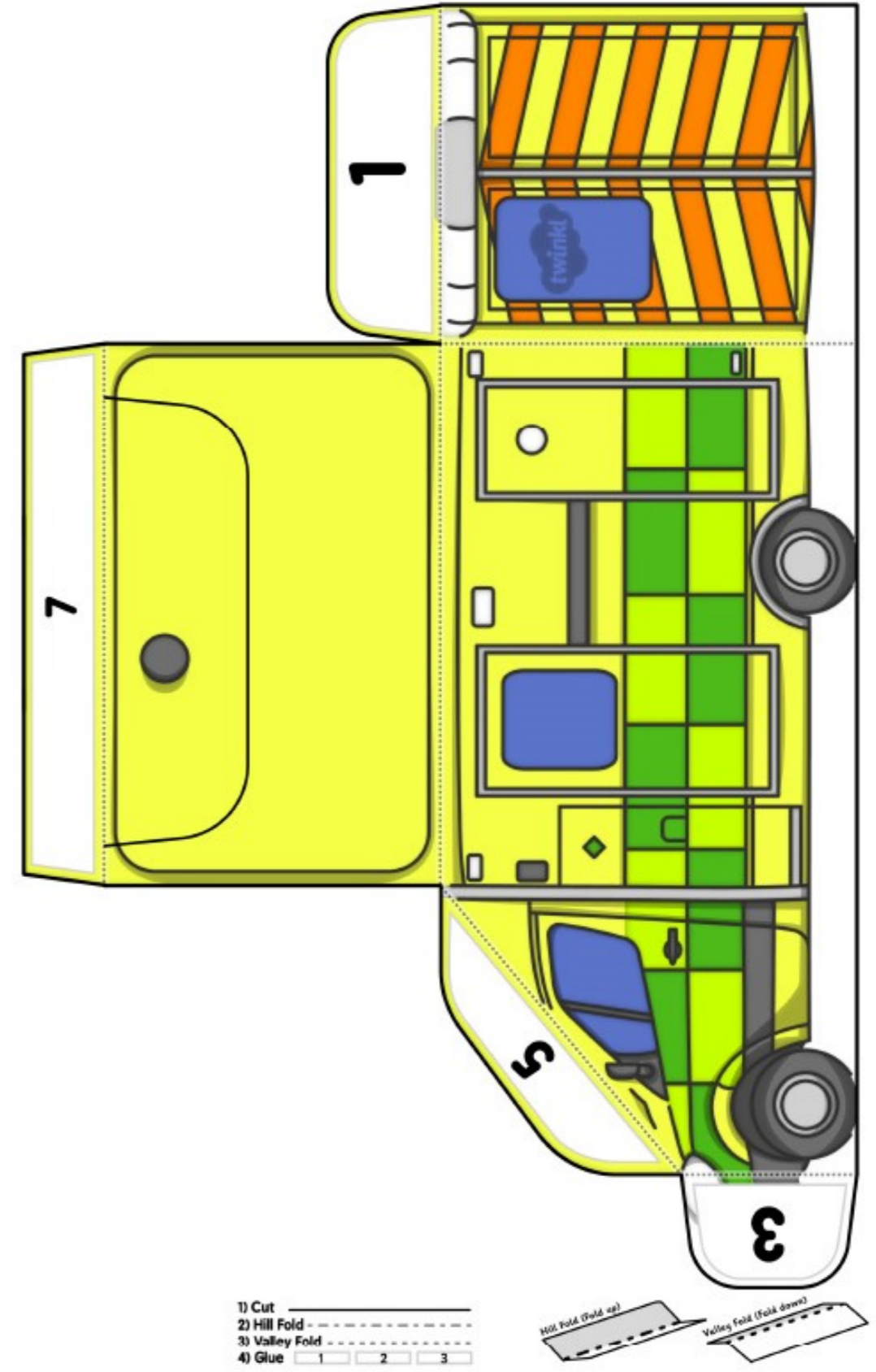

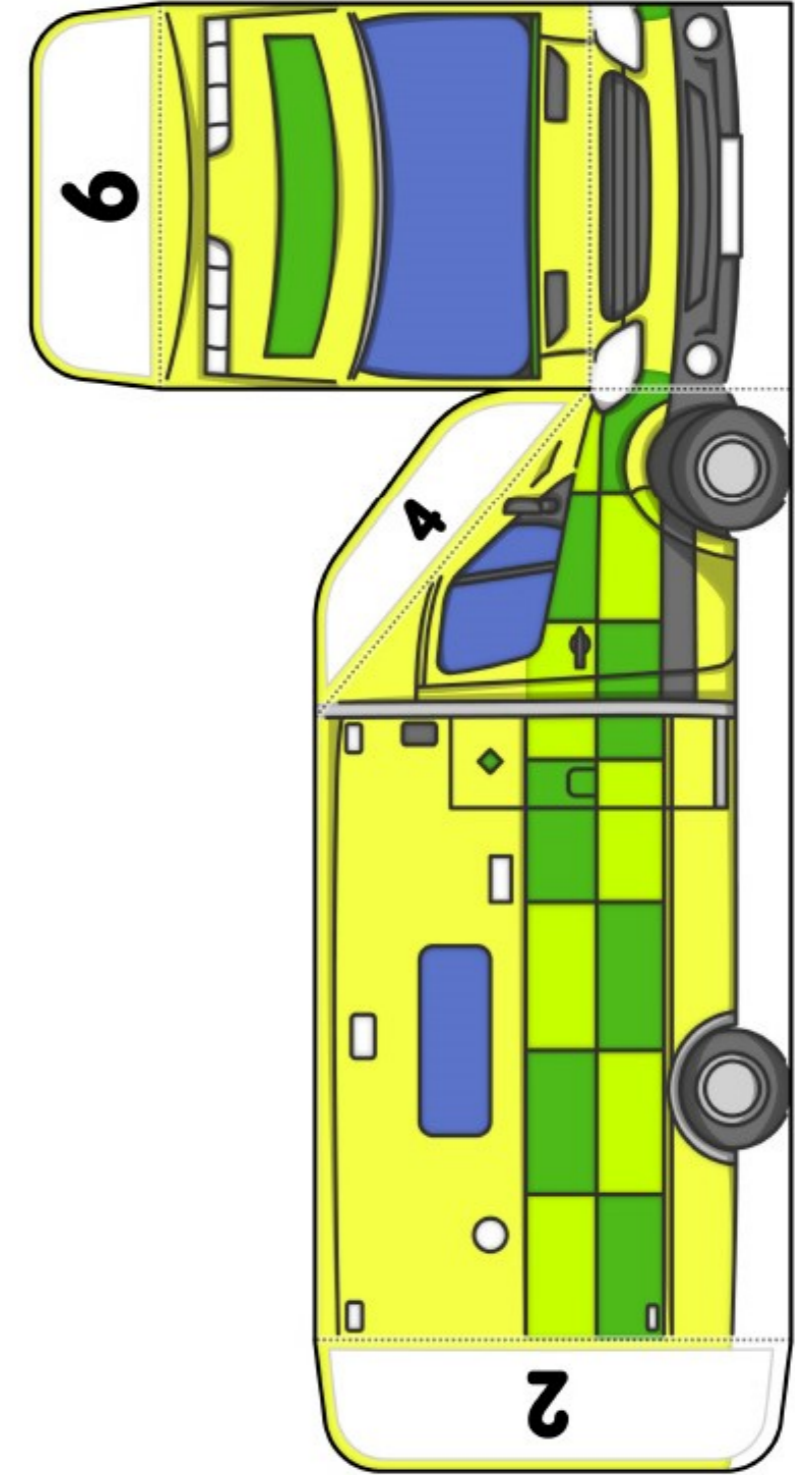

- 1) Cut _____
- 2) Hill Fold - - - - -
- 3) Valley Fold - - - - -
- 4) Glue 1 2 3



Now join the dots to reveal the full pictures!

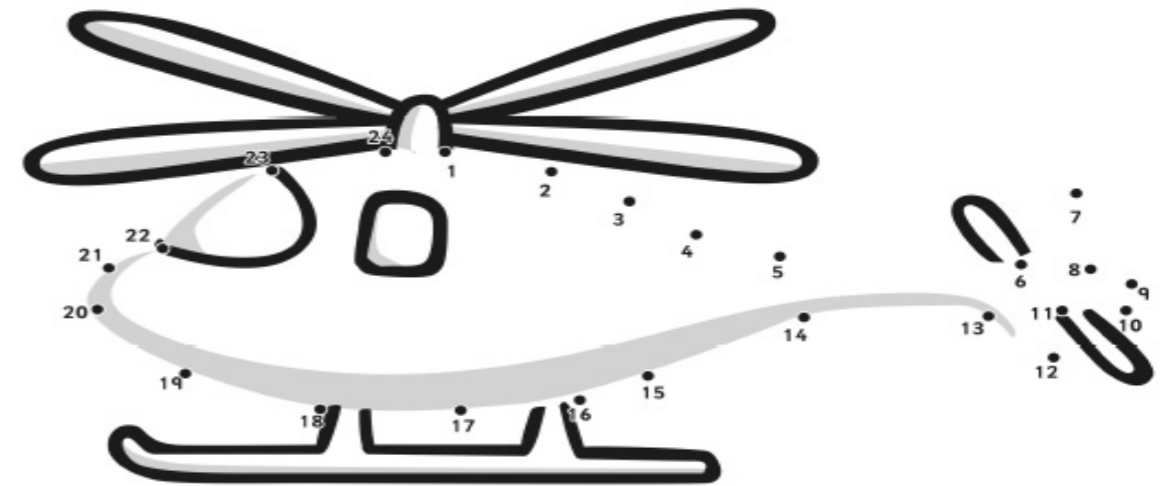

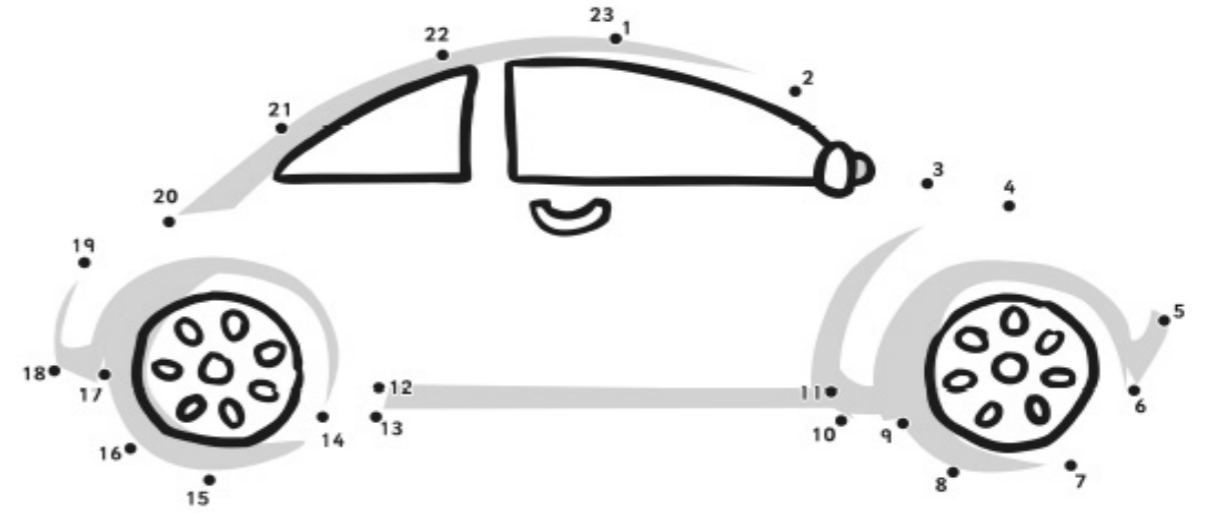
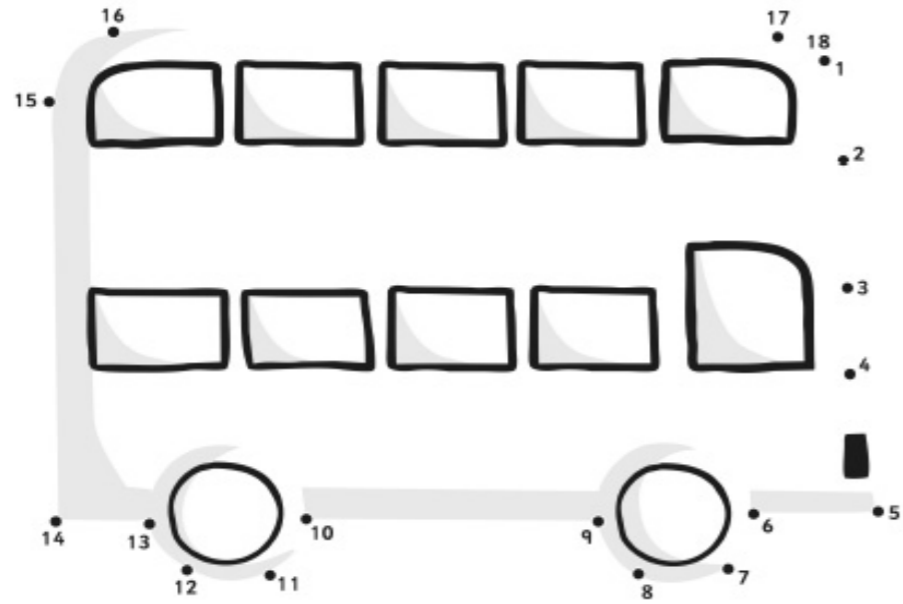
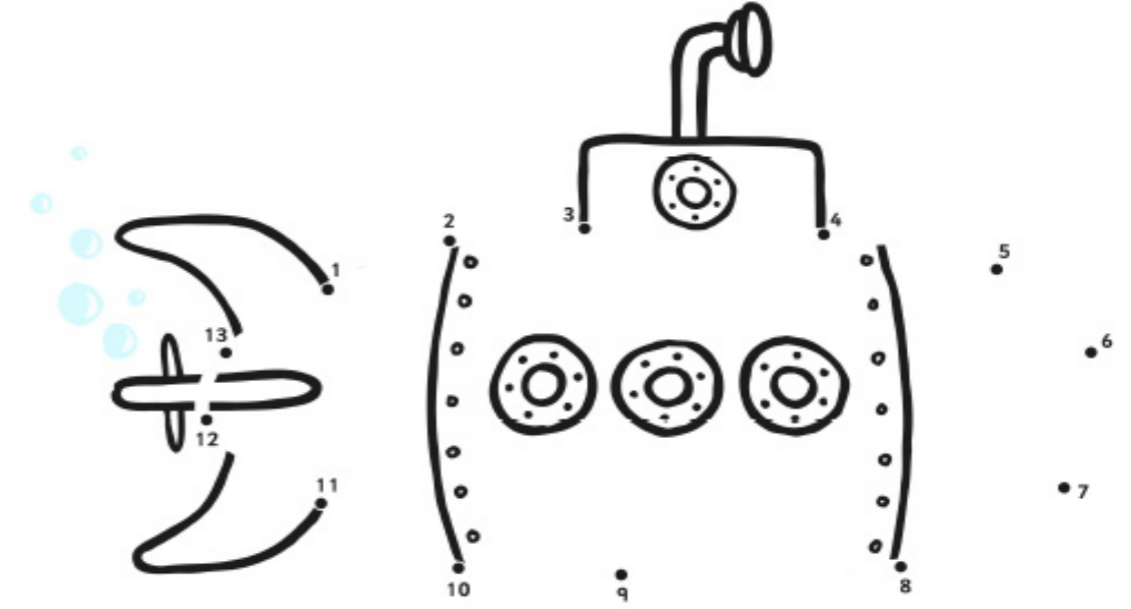
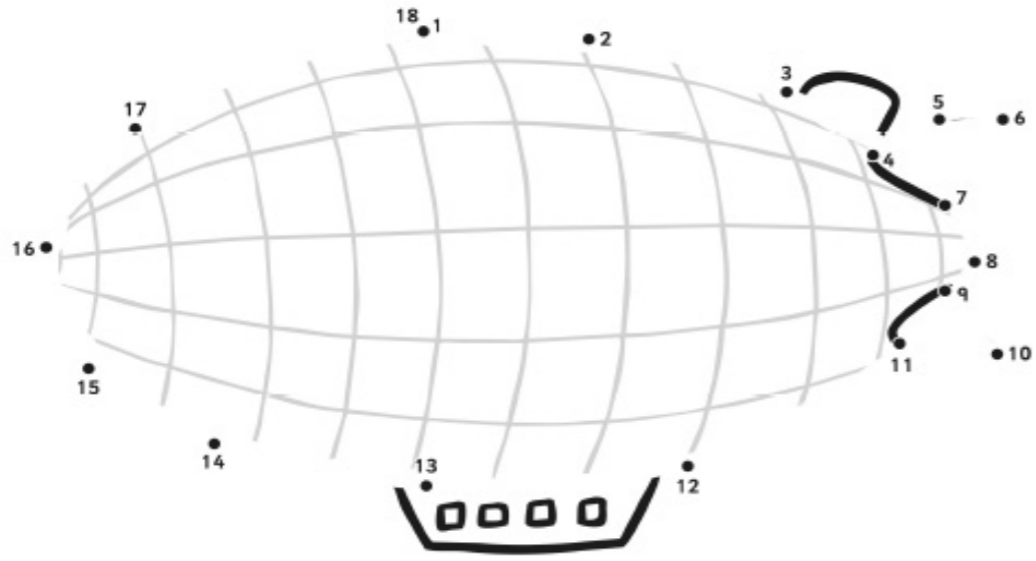

Now it is your turn, design this vehicle :D

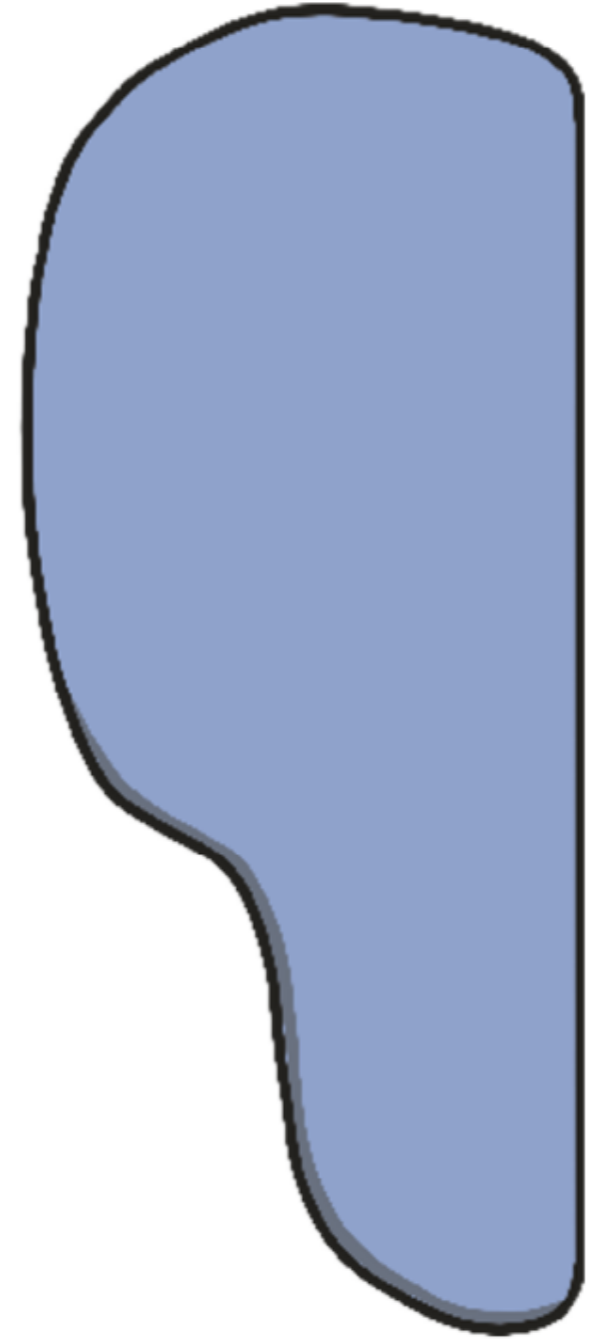

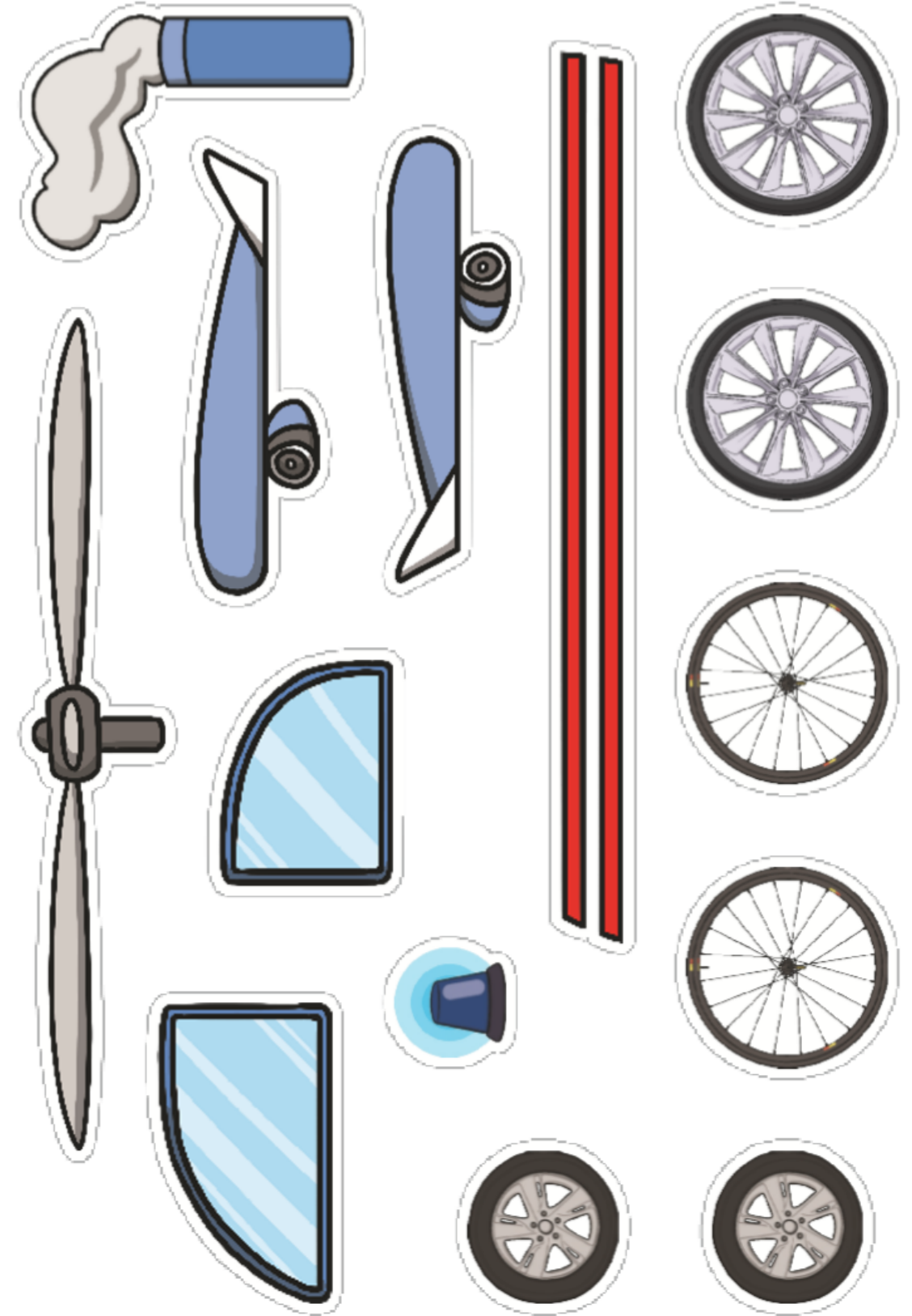

Now show me that you can put the vehicles at their
right place. (first cut them)

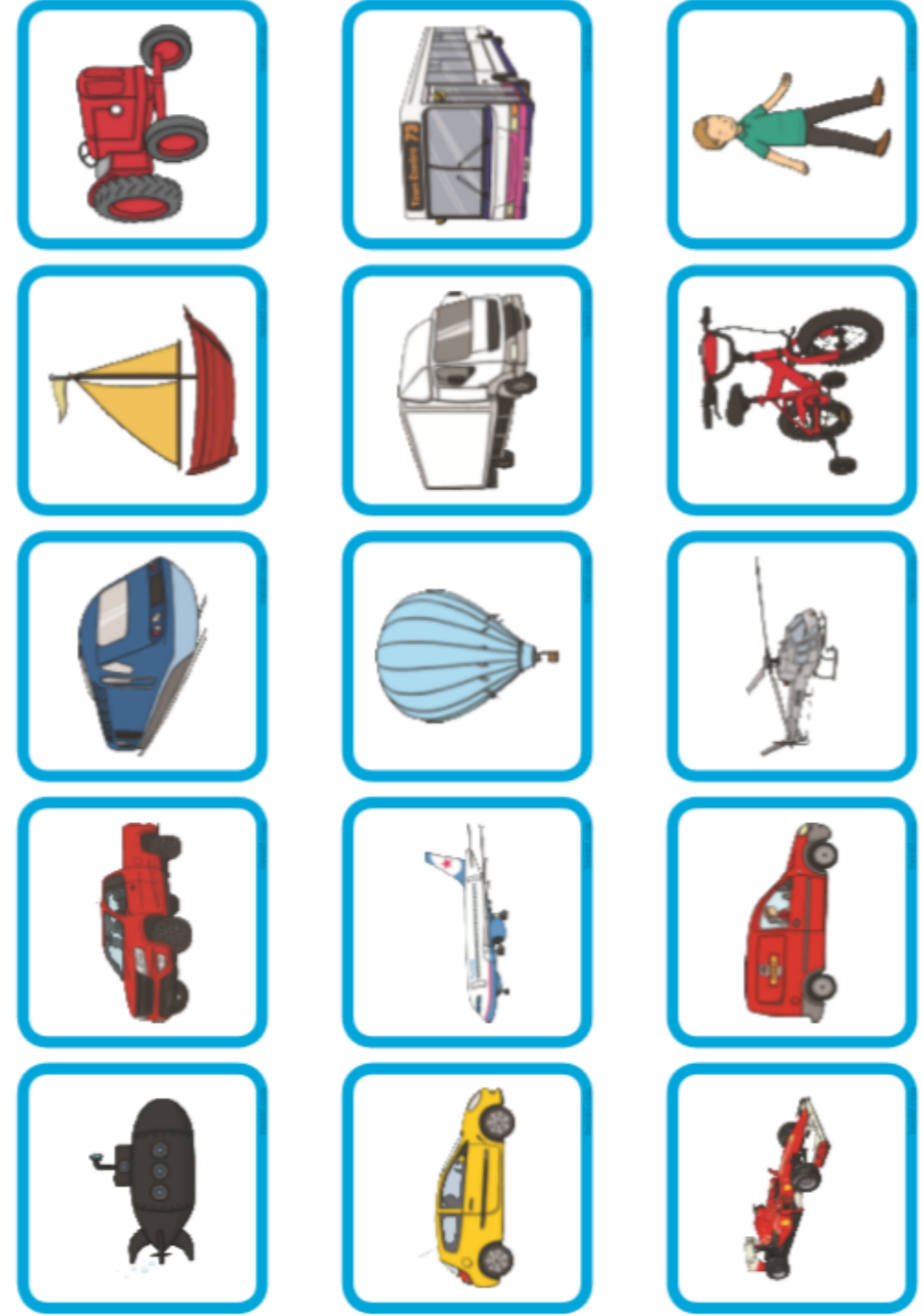

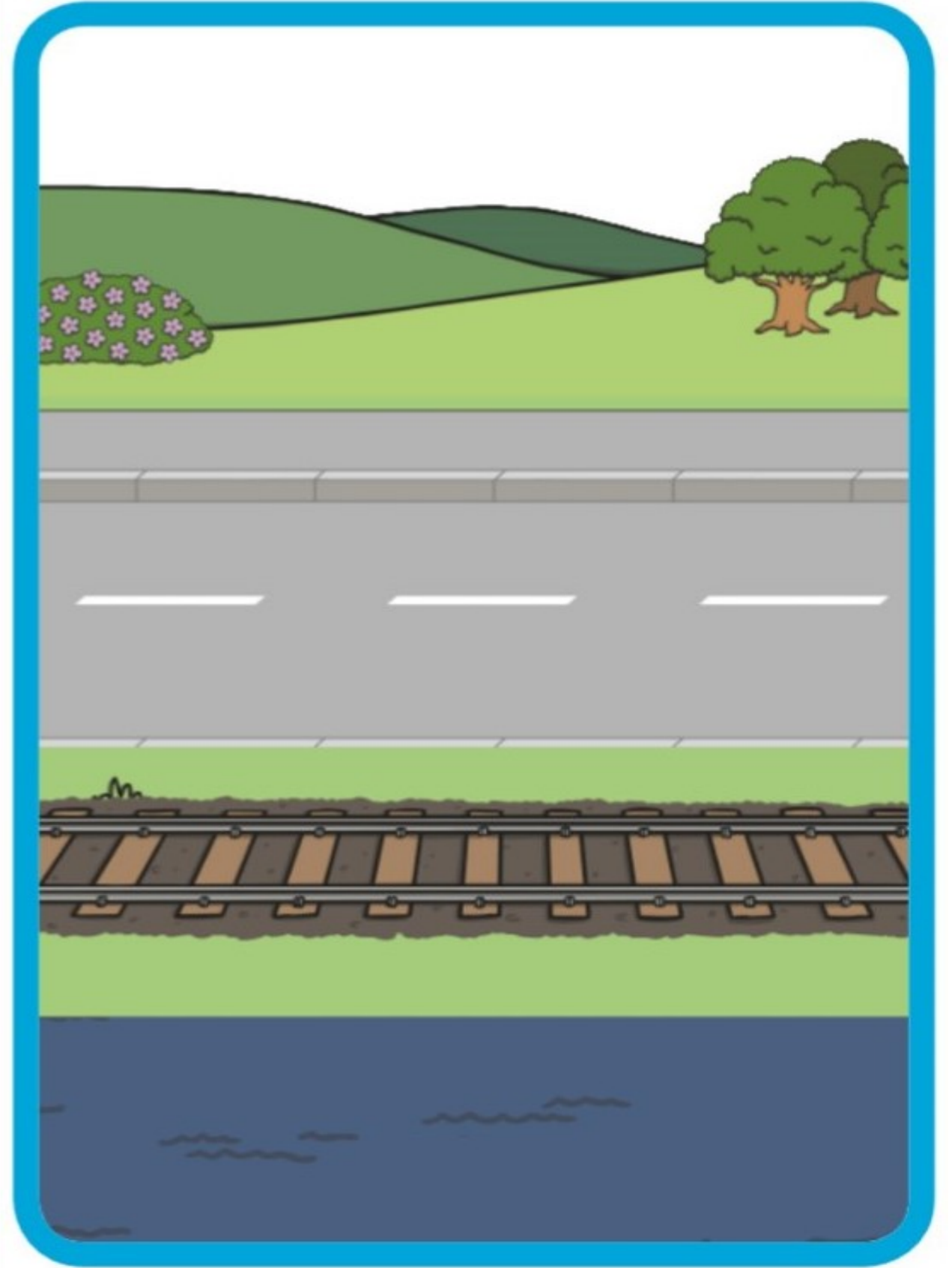

Now, as you look around, have you ever seen these signs?



These signs are specific to people with disabilities.

Sometimes some children are born with mental or physical disabilities.

For example, they cannot walk :

Or they can't see

Or they may not understand everything as quickly as you do...



But with the available facilities, they can live comfortably and be happy because being happy is the right of all of us, they just need more care.



For example, even disabled people can participate in sports competitions and even enter the Olympics, only the name of the competition is specific to them and it is called the “Paralympics”.

Always remember:

“However difficult life may seem, there is always something you can do and succeed at.”



Now come to watch these amazing stories together,
which is about Helen Keller...

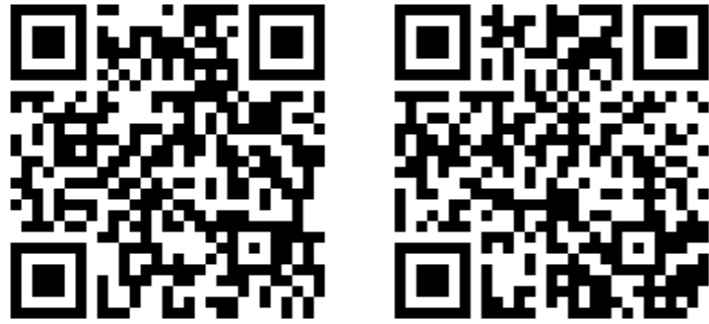

So come to make a poster together for this week,
which is named: “disability week “

Take care of yourself



And please don't forget to take a photo of your **Booklet**
activities and send it to us. We will be surprised and happy
to see your talents. You can also share your beautiful
photos and handicrafts with **#DCAwearetogether** on your
social media pages.



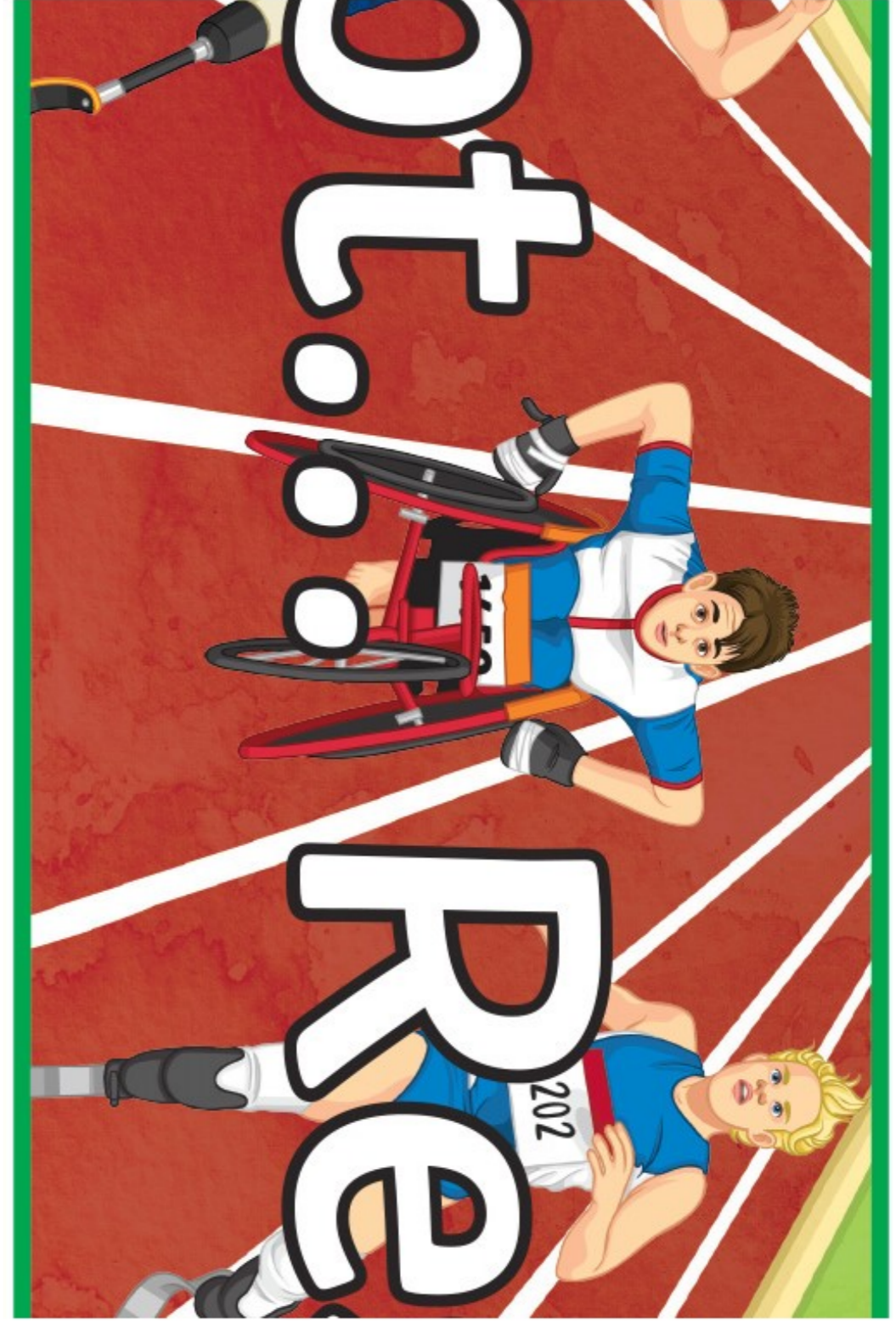

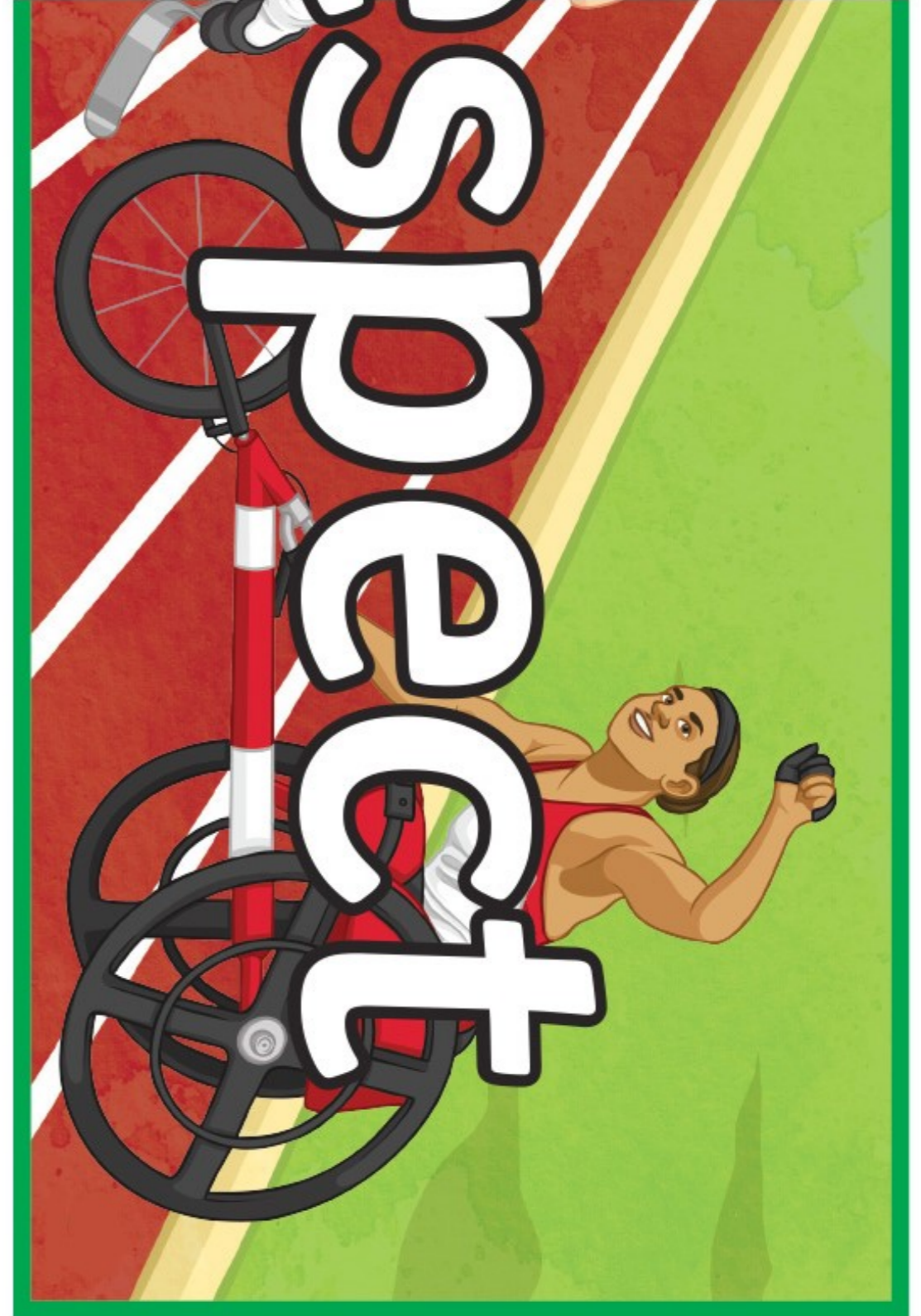



www.dcamaslak.com

@dcamaslak

